



# Philadelphia Rowhouse Manual

**A PRACTICAL GUIDE FOR HOMEOWNERS**

**Rachel Simmons Schade, AIA, Schade and Bolender Architects**

National Trust for Historic Preservation  
Office of Housing and Community Development  
Philadelphia City Planning Commission



City of Philadelphia

## SPECIAL THANKS TO

### Steering Committee

Laura M. Spina, Project Manager  
Jonathan Farnham  
Adrian Fine  
John Andrew Gallery  
Eva Gladstein  
Marty Gregorski  
Patrick Hauck  
Gary Jastrzab  
Bennur Koksuz  
Lauri Michel  
Tania Nikolic  
Carolyn Placke  
Rick Sauer  
David Schaaf  
Alan Urek  
Scott Wilds  
Deanda Wilson

### Stakeholders

City of Philadelphia  
City Planning Commission  
Commerce Department  
Historical Commission  
Office of Housing & Community Development  
Preservation Alliance of Greater Philadelphia  
JRB Historic Restoration LLC  
Mount Airy U.S.A.  
National Trust for Historic Preservation  
Philadelphia Association of Community Development Corporations  
Project H.O.M.E.

### Project Team

Schade and Bolender Architects  
Gallini Hemmann Inc., Graphic Design  
James S. Russell, Editor  
Jeffrey Cohen, Consultant  
Michael Grant, Consultant  
Elise Vider, Consultant

All photos by Schade and Bolender unless otherwise credited  
All sketches by Rachel S. Schade and Susan J. Hadden  
Special thanks to [phillyhistory.org](http://phillyhistory.org) for the use of images from the Philadelphia City Archive.

© The City of Philadelphia 2008

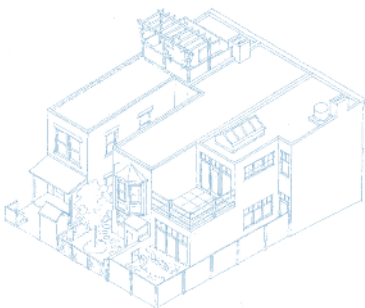
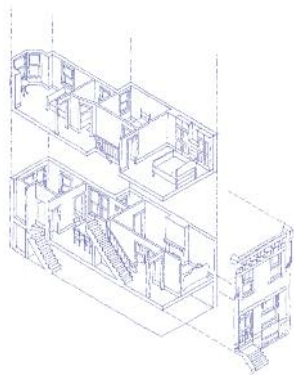
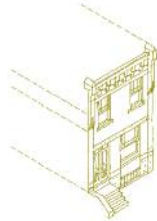
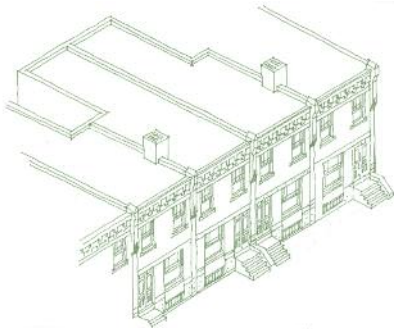

<b>FORWARD</b>	<b>2</b>
<b>INTRODUCTION</b>	<b>3</b>

<b>THE PHILADELPHIA ROWHOUSE</b>	<b>5</b>
Colonial to early 19th Century	6
Mid to late 19th Century	7
20th Century	8

<b>OUTSIDE THE ROWHOUSE</b>	<b>9</b>
Exterior Wall	10
Insulation, Vapor Barriers & Air Quality	12
Porches, Steps, & Stoops	13
Windows	14
Up on the Roof	16
Plantings & Gardens	18
Parking	20

<b>INSIDE THE ROWHOUSE</b>	<b>21</b>
First Floor	22
Kitchens & Laundry	24
Stairs	26
Bedrooms & Closets	27
Bathrooms	28
Flexible Spaces	30
Basements	31
Interior Materials	32
Mechanical Systems	34
Structural Considerations	36

<b>YOUR ROWHOUSE</b>	<b>37</b>
The House is Too Small—A Case Study	38
The House is Too Large—A Case Study	39
Maintaining A Rowhouse	40
Renovations & Additions	42
Permits & Codes	44
Resources	46

*Accessible housing, building materials, carbon monoxide, community gardens, definitions, energy conservation, fire safety, funding for home repairs, historic preservation, housing counseling, lead poisoning, radon, safety, street trees, trash & recycling, windows*

# Forward

In 2003, the City of Philadelphia was selected to participate in the National Trust for Historic Preservation's Preservation Development Initiative (PDI). Funded by the John S. and James L. Knight Foundation, PDI focused on demonstrating the importance of preservation as a core component of neighborhood revitalization.

A Comprehensive Preservation Assessment noted that almost all of the neighborhoods in Philadelphia, from Mount Airy to Pennsport, are defined by their rowhouse streetscapes. As a building type, the rowhouse offers many advantages, but when neglected or poorly maintained, it deprives homeowners of value. It also affects the homes nearby. This manual is one of many projects aimed at celebrating the Philadelphia rowhouse, helping people understand their value (in terms of both history and livability), and aiding rowhouse inhabitants in adapting and maintaining them as a great model for 21st century urban living.

Philadelphia is a city of rowhouses. Their constant revitalization and adaptation illustrates the viability of the city. We don't cook in basement fireplaces or use backyard privies as the earliest rowhouse residents did, but the houses have proven to be so adaptable that we've been able to make them congenial to the 21st century, even with vastly different family structures, social ideals, and technology. The intent of this manual is to help residents value the history and legacy of the rowhouse and its future as a comfortable, community-enhancing, energy-efficient place in which to live.

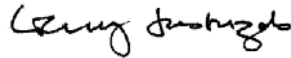

GARY J. JASTRZAB,  
*Acting Executive Director  
Philadelphia City Planning Commission*



LIVESTARCHMAPS. ©2007 MICROSOFT



# Introduction

## What is a Rowhouse?

Philadelphia is largely a rowhouse city, where usually only church spires, a few old factories and imposing institutional buildings rise above the low skyline. The variety of rowhouses is extraordinary, ranging from tiny plain-fronted Trinities to bay-windowed and ginger-breaded Victorian extravaganzas. They have been designed by anonymous Colonial craftsmen and the city's most distinguished architects. They have housed Philadelphians from all walks of life, from workers living near factories in Port Richmond, to the social elite who clustered around elegant Rittenhouse Square.

The Philadelphia rowhouse, most simply, is a one- to four-story house occupying a narrow street frontage and attached to adjacent houses on both sides. It evolved early in the city's history. While William Penn's surveyor envisioned gracious detached homes on green blocks and squares in 1682, speculators quickly divided those blocks near the Delaware River with narrow streets, and erected on them the city's first rowhouses: tiny, more affordable "Trinity" or band-box houses that served people working in the city's burgeoning port. What Penn called the "greene countrie towne" was subdivided into the hierarchy of street and building types that we enjoy today.

Philadelphia rowhouses outnumber all other housing types as they have always been the most space-efficient and cost-effective way to provide homes for a rapidly growing industrial city. Businesses could thrive if their workers could easily get to work, which is why most rowhouses are found clustered around factories and the active waterfronts. Some of the very oldest rowhouses still exist in Queen Village and other eastern neighborhoods. Growth of the city brought larger lot sizes further to the west toward the Schuylkill River, and along the main transportation routes that extended Philadelphia to its land-locked areas to the west and north. Much of the rich fabric of housing near now inactive industry is still occupied, especially in the river wards. By the mid 19th century, rowhouses stretched from river to river, displacing former industrial sites along the Schuylkill. As transportation technology advanced, housing patterns grew out and



away from the dense downtown, and rowhouse construction tapered off as the population started to level and fall in the mid 20th century. The population of Philadelphia County has declined since the 1950's due to a loss of jobs, a search for safer and affordable neighborhoods, and suburban development. In the past twenty years, downtown Philadelphia has grown in population and value as people rediscover city life and see value in rowhouse neighborhoods.

## What Makes the Rowhouse So Special?

The rowhouse is enjoying a renaissance. Philadelphians young and old are seeing the rowhouse as a sensible solution to living in town, providing an opportunity to own and maintain a home, and have a much smaller footprint on the environment, literally and figuratively. People are attracted to city life; young adults are seeking a wide variety of social, recreational, and career opportunities, while mature adults seek the same but appreciate the opportunity to "age in place" and become less dependent on driving. People who have grown up in the city, like the generations before them, see their property values rising as others move in, and build on the support that the security of a valuable property can provide. The many variations of rowhouses can provide an affordable way of living within reach of the heart of the city in houses whose very density makes community much more immediate than in car-focused suburbs.



IMAGES THIS PAGE COURTESY OF PHILLYHISTORY.ORG

WWW.PHILLYHISTORY.ORG



# The Philadelphia Rowhouse

There were three significant eras in the growth of Philadelphia, and the following sections describe the types of rowhouses that were common in each. Small, medium and large houses from each period are identified. While your house may not match these diagrams exactly, you may be able to find some similarities and be able to identify the period in which it was built. Locations identified are neighborhoods with large numbers of a given type. The square footage sizes are for typical houses.

There are many variations on each type of rowhouse; some remain as originally built, others have been remodeled to greater or lesser extents to meet contemporary needs.

# Colonial & Early 19th Century Rowhouses

## SMALL

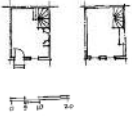

**Known as:** Trinity, Bandbox, Father, Son & Holy Ghost

**Size:** 400-600 sq. ft.

**Location:** Society Hill, Queen Village, Old City, Kensington

**Defining Characteristics:**

One entry, winder stair, no running water, community “necessaries”, often mid-block with no street frontage

## MEDIUM

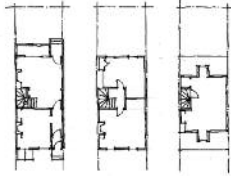

**Known as:** Double Trinity, London House

**Size:** 1,000-1,800 sq. ft.

**Location:** Society Hill, Queen Village, Old City, Kensington, Washington Square

**Defining Characteristics:**

Three stories plus basement, gable roof (ridge is parallel to front of house), two fireplaces, rear yard with access

## LARGE

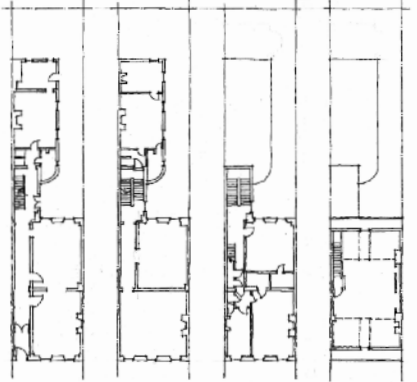

**Known as:** Federal or Georgian Town House

**Size:** 3,000-7,000 sq. ft.

**Location:** Society Hill, Queen Village, Old City, Kensington

**Defining Characteristics:**

Three to four stories, with narrower but deep extension to reach the back of the main house; first floor two rooms deep, then offset to allow more light into main volume



# Mid to Late 19th Century Rowhouses

## SMALL



**Known as:** Workingman's house

**Size:** 1,000-1,600 sq. ft.  
on two floors

**Location:** Center City, South Philadelphia, North Philadelphia, West Philadelphia, Manayunk

**Defining Characteristics:**

Entry vestibule, shed kitchen, shallow closets, indoor plumbing, central heating

## MEDIUM

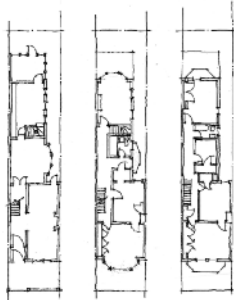

**Known as:** Streetcar town house

**Size:** 2,200-2,500 sq. ft.  
on 3 floors

**Location:** North Philadelphia, South Philadelphia, West Philadelphia

**Defining Characteristics:**

Front porches, bay windows, tall ceilings, elaborate woodwork

## LARGE

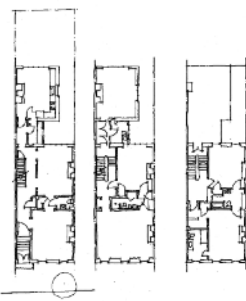

**Known as:** Urban mansion, townhouse

**Size:** 3,000-6,000 sq. ft.  
on 3-4 floors

**Location:** Rittenhouse Square, North Broad Street, South Broad Street

**Defining Characteristics:**

Three to four stories, 18-22 feet wide, carriage houses, two stairs, multiple formal rooms, rooms for live-in help, skylights over stairwells, lightwells, ornate fireplaces and paneling

# 20th Century Rowhouses

## SMALL



**Known as:** Subsidized Public Housing

**Size:** 1,000 – 1,200 sq. ft.

**Location:** Gray's Ferry, Eastwick, North Philadelphia

**Defining Characteristics:**

Two-story, steel windows, no basement, shared exterior space

## MEDIUM



**Known as:** Porchfront

**Size:** 1,200-1,500 sq. ft.

**Location:** East Falls, Francisville, North Broad Street, West Oak Lane

**Defining Characteristics:**

One-car garage at lower level, elevated front yard and entry, two-story, front porch, bay at second floor, shared back deck between wings

## LARGE

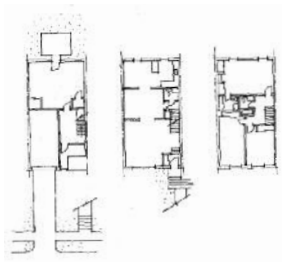

**Known as:** Postwar townhouses, Airlites, Straight-throughs

**Size:** 1,500 – 1,800 sq. ft. on two floors

**Location:** Southwest Philadelphia, Northeast Philadelphia, Roxborough, East Mount Airy

**Defining Characteristics:**

One-car garage at lower level, elevated front yard and entry, two-story, sometimes with front porch

# Outside the Rowhouse

Most rowhouse maintenance problems start on the outside, so being aware of potential trouble areas is important. It is also necessary to understand why specific elements of the exterior were built, so that you can be careful to replicate the function of the detail—if not the style.

Often it is tempting to undertake a quick fix, but it is important to understand the potential benefit of spending a bit more to maintain the individual character of the house, and the rowhouse block as a whole. The Resource Section on page 46 offers sources for funding many house repairs for qualified homeowners.



# Exterior Wall

## Next to neglect, water is your rowhouse's worst enemy.

BRICK is ubiquitous in Philadelphia. Most of it came from local manufacturers; it was plentiful and inexpensive. The outside surface of the brick is the most durable because it was exposed to high heat when it was fired. The interior material is much softer, and will wear quickly when exposed to weather. Brick is porous, which means a small amount of water gets inside the brick, but it also dries readily. Bricks that have lost their hard outer surface may allow too much water in.

Brick is held in place with mortar, and sometimes the mortar deteriorates before the brick does. This can provide a way for water to get inside the wall. Many nineteenth-century rowhouses have very thin mortar joints called butter joints. If these have deteriorated, mortar in a butter joint needs to be removed by hand, not by sawing-out a larger joint. Mortar needs to have similar properties to the brick so that it will expand and contract at the same rate.

Brownstone is a handsome material when installed properly—the way it came out of the earth in horizontal layers. There were some rowhouses with entire façades of brownstone, but most frequently it is found at the base of the façade, and as window and door surrounds. When deteriorated it should be replaced with matching stone, not patched or covered with stucco. Granite, marble, and green serpentine stone can be found on some houses as well; each with varying degrees of durability. A good mason is invaluable in determining the best way to restore and maintain a stone facade.



*Top: Brick damaged by dripping air conditioner  
Bottom: Deteriorated brownstone trim*



**Do not sandblast brick or clean it with acid as this can remove the durable exterior skin of the brick, which will quickly erode the wall.**

**Do not paint brick with material that is not breathable: water needs to be able to find its way out of the wall so it can evaporate. If it's caught within the brick and the temperature drops below freezing; the water will expand and cause the brick surface to break, or spall.**



Many rowhouse façades have been refaced, sometimes because of a desire to modernize the look, and sometimes to mask problems. Any decision to reface should be carefully considered in light of the visual impact on the neighborhood and the potential damage to the structure. Stucco can be successful if installed with care. Because it was not used originally, vinyl or aluminum siding is usually detrimental to a rowhouse. To cover a masonry wall with any type of material requires a building permit and an inspection to insure that the wall is structurally sound. Do not paint masonry that has never been painted. Remove paint from masonry carefully to restore the original appearance.

Kitchen and bathroom additions to rowhouses were often built of less expensive material; usually wood framing with wood siding. All wood surfaces should be maintained and painted regularly. Most paint manufacturers have paint color selection guides to assist in creating a harmonious look.



**Avoid putting air conditioners through solid walls; a hole through the exterior wall can cause damage by allowing moisture to enter. Exhaust fans should vent through the roof or through the back of the house whenever possible.**



*Left: Permastone and stucco cover original brick*

*Center: Stucco over a bay window and mansard roof*

*Right: Aluminum siding on bay windows*



*Satellite dishes are unsightly and should be placed on the roof; away from view of the street.*

# Insulation, Vapor Barriers & Air Quality

New housing must meet modern energy-efficiency standards, but most rowhouses were built with minimal insulation. Rowhouses are inherently economical because shared party walls minimize exterior exposure. For comfort and energy savings, older homes should be retrofitted by adding insulation to the roof and to the exterior walls.

## Roof Insulation

Adding fiberglass batt or blown-in insulation to a rowhouse attic is a very cost-effective way of reducing energy use. It should not be stuffed in tightly: a couple of inches of airspace should always be left between the top of the insulation and the underside of the roof. Some rowhouses have almost flat roofs and no attics. When a new roof is installed, it's possible to add rigid insulation between the decking and beneath the roofing material.

## Wall Insulation

For masonry rowhouses, the most common way to insulate the front and rear walls is to place metal or wood strips on the inside walls deep enough to accommodate the selected insulation. On top of the strips stretch a vapor barrier (see below) and new drywall for a finished interior wall. You will lose a bit of space to the insulating layer, but it's worth it. As at the roof, leave a bit of airspace between the insulation and the exterior wall to avoid trapping moisture.

## Vapor Barrier

A vapor permeable air barrier is a thin layer of special plastic or composite material that prevents moisture from getting trapped inside the wall, where it can nurture mold or attract pests. In our climate, the general rule is to place the barrier behind the finished interior wall, with its water-resistant surface facing toward the inside.

## Air Quality

Houses need some fresh air to prevent indoor air pollution. Older homes are not built as tightly as modern ones, and older materials did not contain the potentially toxic substances of some modern materials. Too much air leakage can be drafty and inefficient and cause too much heat loss.



**Old versions of blown-in insulation—rock wool (sometimes called “rotten cotton”) sometimes contain toxic material like asbestos. Before replacing this kind of insulation, have it tested. A licensed professional must remove and dispose of hazardous materials. Find one in the phone book under Environmental or Ecological Services.**

**To avoid fire danger, insulation must not be allowed to touch recessed lighting fixtures or other heat-generating devices in the wall or ceiling. If you have any doubts, call in an electrician.**

Indoor air pollution occurs for a variety of reasons.

Modern composite materials can break down chemically over time, releasing toxins into the air in a process called “off-gassing”. Formaldehyde in plywood and volatile organic compounds (VOC's) in paint are two examples.

Carpets and carpet pads can trap dirt and dust that support mites and unhealthy substances that can affect the health of the occupants, especially if they have allergies. Traditional rowhouse floors are wood and tile which are easier to keep clean. Area rugs can be laundered and aired. Take care that rugs are flat enough that they do not pose tripping hazards.

Anything that introduces smoke into the air—smoking, lack of exhaust at the range, exhaust from un-maintained furnaces and poorly performing chimneys at wood-burning fireplaces—reduces the quality of the interior air.

## VAPOR BARRIER

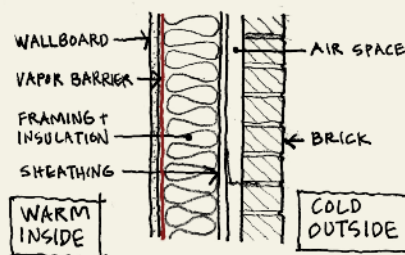

Section through a brick wall showing vapor barrier location

# Porches, Steps, & Stoops

Sitting on the stoop and watching the action on the street is for many what living in Philadelphia is all about. Kids playing street hockey or double dutch brings activity and may also make neighborhoods safer.

The architecture of the street façade can help connect people to the street. Most existing rowhouses are a few steps up from the street, so with partial height curtains you can preserve privacy yet still be able to see what’s happening outside. By contrast, street-facing garage doors obscure the view and make streets look unoccupied.

Many rowhouses were built with front porches. When rowhouses have front porches, they are usually set a few feet above the sidewalk, offering an enjoyable as well as safety-enhancing vantage during nice weather. Often these porches have been converted to indoor space to enlarge the house—but this is rarely an appropriate idea. A restored front porch can provide protected outdoor space and a way to monitor street life. Often porches were installed on the ground in front of the house, rather than over a basement area. Over time, temperature fluctuation and erosion can cause the porch foundations to shift and cause the structure to move independently of the rest of the house. A good contractor can shore up the foundations and recommend ways to restore columns, decking, and roofing.

Keeping trash neatly stored and litter picked up not only contributes to public health, but also conveys the sense that residents use the street as their “living room.” Research shows that criminals avoid clean, well maintained streets in favor of vandalized and poorly maintained ones, which signal that residents have resigned themselves to crime.

One of the best features of the rowhouse street is that you have so many neighbors close at hand. Many blocks stage regular block cleanups or yard sales, followed by a potluck dinner. They’re fun, and they build solidarity and collaboration to solve problems. It is easy to get a permit from the Streets Department to close the street for your event: [www.phila.gov/streets/blockparty.html](http://www.phila.gov/streets/blockparty.html)



PHILLYHISTORY.ORG



Top: West Philadelphia porches in 1954

Bottom: Recessed porch under projecting bay window



**Wood elements need to be well painted. Loose steps and boards should be repaired promptly, and loose railings and balusters should be maintained. If the materials have deteriorated, replace them with what was used originally. Wrought iron is not an acceptable alternative to wood columns or brick piers.**

**A working light keeps the sidewalk and street appealing as well as visible—and prevents stumbles in the dark. Lighting shows that the street is watched and occupied. Avoid floodlights and other types of fixtures that shine directly in the eyes of passersby. The intense light creates shadows where criminals may lurk. An automatic timer is a good way to insure that the light goes on even if you’re not at home.**

# Windows

Windows say a great deal about your rowhouse. They also contribute to the comfort, appeal, and energy efficiency of your home. The way windows look has long been driven by the technology of the time when they were made. That's why Colonial houses have six or nine small panes per sash. As glass technology improved, the panes of glass grew ever larger.

## Window Replacement

In a city as historic as Philadelphia, it is worth the effort to save original windows that are not beyond repair. Many windows can be restored to their original condition and continue to operate well. Recent technical advances in windows have focused on saving energy. Anyone with single-glazed windows should consider upgrading to insulating glass. The energy savings and improvement in comfort (by reducing drafts and noise) will quickly pay back the investment. If the existing window frame is in good condition, you can usually replace the sash and glass for a modest investment. If both window and frame are in poor condition, you'll need to install entirely new windows, which costs more and is more disruptive. For extensive retrofits, tax credits or energy credits may be available.

## Modern Window Materials

Replacement windows come in a variety of materials. Keep in mind that these are a long-term investment in your home.

- Wood windows are widely available with traditional styling and modern energy saving options. They require regular painting.
- Wood clad with aluminum: lower maintenance (they don't have to be painted), but may detract from the historic appearance if the profiles don't match the windows they replace. They are available in limited colors. Once the finish fades, these materials are more difficult to recoat successfully.
- Vinyl windows: Because the strength qualities of vinyl vary considerably from wood, the profile of vinyl residential windows may be unappealingly thicker than both wood and aluminum windows. They are available in limited colors and are difficult to refinish once they chalk and fade. In shaded locations, they may mildew. Lower-priced vinyl windows may have poor fit.



*Top: When replacing doors and windows, don't reduce the size of the original openings.*

*Bottom: Paint wood windows and trim regularly.*



## Storm Windows

Storm windows reduce drafts and provide insulating value. They can be installed on the exterior of the house, or on the interior. Lightweight exterior aluminum or vinyl storm windows can detract from the appearance of the house, especially as they age. On low-quality units, glass lights can fit poorly and bind; screens can be flimsy. A high quality exterior storm window may cost as much as a good replacement window. However, it may be a good alternative if you have a uniquely shaped or over-sized window.

Interior storm windows are easier to install, often less expensive, and will not change the exterior appearance of the house. (They may be the only acceptable way to improve the energy performance of historic houses with original single-pane windows.) A rigid piece of Plexiglass is cut to fit the window, and held in place by a light plastic frame and magnetic tape, making it easy to remove. These can be ordered on-line, and installed by someone with very limited carpentry skills.



To rehabilitate existing windows, a contractor may need to remove the sash from the frame, strip layers of paint, and re-glue the sash. The chains and weights that counterbalance the window as it slides up and down may have to be repaired or replaced. It is easy and inexpensive to add weather stripping to reduce drafts and save energy. Substantially rotted sash and frames must be replaced. Most replacement windows come with a release so that they can be swung-in or tilted-in for easy cleaning—a very desirable feature for a rowhouse.

Many houses in Philadelphia originally had shutters for security and to keep the summer sun out. If added, they should be in a style and material appropriate to the house. Shutters originally had solid panels at the ground floor, and louvered panels on upper floors. Fake shutters should be avoided.

Before air conditioning, canvas awnings, along with wood shutters, were the chief way Philadelphians could keep their homes cool in summer. Combined with ceiling or window fans, they can still maintain comfort on all but the hottest days. Aluminum and fiberglass awnings are detrimental to the historic character of the street.

Security bars are meant to keep people out, yet not imprison the homeowner. They should be designed with sensitivity to the appearance of the house. An excessively fortified appearance suggests a vulnerability to crime, (according to research), which appeals to criminals, while giving homebuyers second thoughts. Protection should be visible, yet as discreet as possible. Any bars or gates installed on windows and doors must be able to be opened from inside without a key in case of fire. Quick release mechanisms can be installed without compromising safety.

## ANATOMY OF A DOUBLE HUNG WINDOW

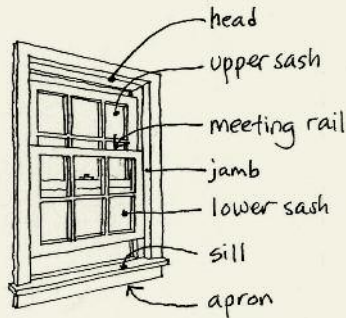

Parts of a window

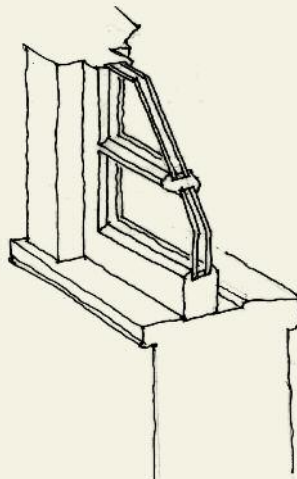

Double pane insulating glass



preferred

Authentic divided light,  
simulated divided light

not recommended

Snap on grid, between  
the panes grid

# Up on the Roof

Keeping water out of your rowhouse is the single most important way to ensure its longevity and to minimize your repair bills. The roof is your first line of defense against water.

Most rowhouse roofs appear “flat”, although they are actually gently sloped toward a drain. A slope of 1/4” vertical height over a distance of 12” is the minimum for water to move.

- Modified bitumen is a low tech, lower cost, reliable roofing system. Rolls of flexible material are adhered to the roof and to one another, and the joints are sealed. It is easy for a professional to detect a leak.
- Rubber roofing, or EPDM, is a commercial roofing type sometimes used on houses. Leaks are harder to detect than in the above system.

Some rowhouses have pitched roofs, which are covered in painted metal or shingles.

Sunlight is the worst enemy of roofing materials. A silver or white coating on the roof helps to protect the materials, and also minimizes heat build up in the attic or top floor.

The roof must slope to the downspout. Rainwater gets into the downspout in one of two ways:

- At the front and sometimes at the rear as well, the water enters a roof drain, which may penetrate the cornice or parapet in a scupper, and joins the downspout on the outside of the building.
- At the rear, and occasionally at the front, the water drains into a gutter that runs the length of the façade, which then joins the downspout.

The final destination of the water must be on your property. It is illegal to divert storm water on to sidewalks, streets or adjoining properties. One reason for this is that if drained water freezes, someone could slip on the ice.

Current building code requires that storm water must end up in the domestic sewer line, either in a direct connection from the cast-iron boot of the downspout, or from there through the lateral pipe in your basement, and then out to the street sewer.

Some sections of Philadelphia have a combined storm water and sewer system, which means that when it rains hard, the sewers can fill up and send raw sewage overflow into the rivers. Anything you can do to hold rainwater on your site and let it discharge more slowly will relieve pressure on the sewer system, and improve the water quality in our rivers.

## Roof Decks

A roof deck is a great amenity in a rowhouse, especially since many rowhouses have small yards surrounded by two- or three-story buildings. Often the house has a rear ell that can be accessed from an upper floor. It is usually inappropriate to build a deck on the top floor, unless the building is big enough that you can set the deck and railing back from the building walls.

- Zoning and building permits are required for a roof deck. Zoning regulations for decks are complex, so it is best to check with the Department of Licenses and Inspections early in your planning process.
- The deck does nothing to waterproof your house. That is still the job of the roofing system, so make sure that the roof is in very good condition prior to installing a deck. Any penetrations in the roof must be sealed properly.
- The deck railing is the most important safety feature. It must conform to the code for height (usually 36” above the surface of the deck) and lateral strength, so that someone can fall or push against it without it giving way.
- The deck needs a walking surface. Often this is an independent wood structure on top of the roof. Storm water must be able to access the downspout, and not be trapped on the roof. The walking surface should be easily removable to check for debris clogging the downspout.

## Green Roofs

- A green roof is one that is covered by low light-weight vegetation. The soil for the plants may either be placed directly on the roofing membrane or may be in pallets that can be lifted on to the roof one by one. The pallet installation can be done by a homeowner; the direct installation should be done by a professional. In both cases, it is important to protect the roof drains from a build-up of soil or plant materials.
- The main benefit for the rowhouse owner is the insulating quality of the plants and soil, as the roof is the often the largest exposed surface of the house. The green roof protects roofing materials by keeping the sun from hitting them, thus improving the lifespan of the roof.
- You must consult with a professional if you are interested in installing a green roof. The added weight of soil and water may be too heavy for your existing roof structure.



*The Tale of Four Cornices:* This photo shows the evolution of the ornamental cornices on a row of houses in South Philadelphia. On the right are two original painted metal cornices, one painted two colors to highlight the detail. The middle cornice was covered with vertical aluminum siding; the cornice had probably deteriorated or perhaps the homeowner was tired of painting and wanted a "facelift". At the very left, the entire cornice has been removed; only the brick remains. This original brick was laid up with texture for attaching the cornice.

## CORNICES

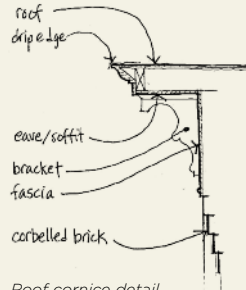

*Roof cornice detail*

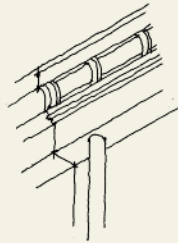

*Downspout through cornice*

## SOLAR POWER

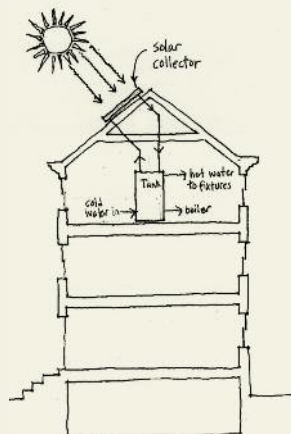

*Solar energy for heating water is practical in Philadelphia.*

# Plantings & Gardens

Rowhouses may not have space for broad lawns, but there are lots of opportunities to plant trees and shrubs on even the smallest house lot. Urban gardening is not only extremely satisfying, it is also manageable for people with busy lives.

*“Trees provide shade and beauty and so much more. A single tree on your property can increase the value of your home and help keep it cool. A neighborhood filled with hundreds of trees is a more desirable place to live... Trees improve air quality across large areas by filtering out pollutants and slowing the formation of ground-level ozone. They reduce flooding by absorbing water, and improve the quality of storm runoff entering rivers and streams.”*

FROM TENDING THE URBAN FOREST, PENNSYLVANIA HORTICULTURAL SOCIETY, SUMMER 2006

## Window Boxes & Planters

Adding window boxes and planters inexpensively improves the appearance of the front of your home. Mix plants for sun or shade, depending on exposure. (Numerous guidebooks can be found in libraries and bookstores.) Be sure the soil is well-drained. Firmly attach boxes above a sidewalk against the forces of wind. Take care not to damage the exterior wall or create opportunity for leaks when attaching support brackets.



**Good Fences Make Good Neighbors: The Philadelphia Zoning Code restricts the height of fences and garden walls to 6 feet. Barbed wire and razor ribbon are not permitted. Privacy can be achieved with visually solid fencing, but louvered or offset uprights allow breezes to flow through.**



Left: Original wrought iron fence



Right (top): A bountiful window box

Right (bottom): A cheerful planter made from a tire



## Gardens

You may find you can squeeze shrubs or a garden bed into some very small spaces. Depending on the orientation of your home, you may find that you don't have enough light for sun-loving flowers, but many plants do well in shade: hosta, ferns, pachysandra, myrtle. Check hardiness charts for climate-suitable species. Be attentive to invasive plants and "weed" trees that grow and spread very quickly, and crowd out native varieties. Some are difficult to remove once established. Keep ivy and other vines off of the house. Their roots can destroy mortar.

## Street Trees

In Philadelphia, the Fairmount Park Commission is responsible for maintaining street trees. Streets with trees not only seem lush and inviting, the shade makes the streets more comfortable and can even noticeably lower air-conditioning bills.

Young trees need to be nurtured carefully for the first couple of years after they are planted. All trees have a limited life span, and it is best to remove them before disease or rot sends limbs crashing down.

## STREET TREES



*A water-filled irrigation bag keeps young trees from drying out.*



WIKIMEDIA



*Beware of Invasive Species.*

*Top: English Ivy*

*Bottom: Virginia Creeper*

*Which street looks more inviting?*

# Parking

Most of the streets and houses in Philadelphia were designed long before the automobile became so ubiquitous. There will never be enough room to accommodate everyone's cars, let alone right in front of their house. Reducing parking problems can be done in two ways: don't have a car (especially a second car) and store the vehicle you must have more gracefully.

## Do You Really Need a Car?

Owning and operating even an inexpensive car costs at least \$6,000 annually in Philadelphia—for many models, the cost is much more. It is prudent to assume gas costs will go even higher, but it is getting easier to substitute other forms of transportation for a car.

- **Car Sharing**—These membership organizations make cars locally available when you need them. They're not practical for daily commuting but are economical for errand-running and short trips. All sorts of vehicles are available by the hour.: *Phillycarshare.org*, *Zipcar.com*, *Ucarshare.com*
- **Car Rental**: Renting cars is relatively inexpensive for long trips, hauling, occasional errands and weekend getaways.
- **Car Pool**—Many companies encourage carpooling by helping match riders, offering subsidies, and providing more convenient parking for carpoolers at the workplace.
- **Public Transportation**—Philadelphia is among America's best-served cities for public transportation, so it's worth considering. An easy-to-use trip planner can be found at *www.septa.org*.

## On Site Parking

Any new parking on your own property requires a permit from the city, because it entails penetrating the sidewalk with a sloped curb cut. Neighbors may object to new parking because it can eliminate street spaces and look unsightly. Any on site space must entirely accommodate the vehicle. It cannot project into the sidewalk or street. A street lined with parking garages can be unwelcoming, and actually reduces parking capacity by eliminating street spaces. Parking in alleys can be gracefully handled by minimizing curb cuts and maintaining walkways and street trees. Appealing gates or openwork mesh will make a better impression than roll-down security doors or blank panels. Using paving stones or bricks can enhance an alley or private parking space by making it look like a courtyard where autos are occasionally found rather than a parking lot.



Major streets were never intended to have curb cuts and garage doors.

## GARAGE

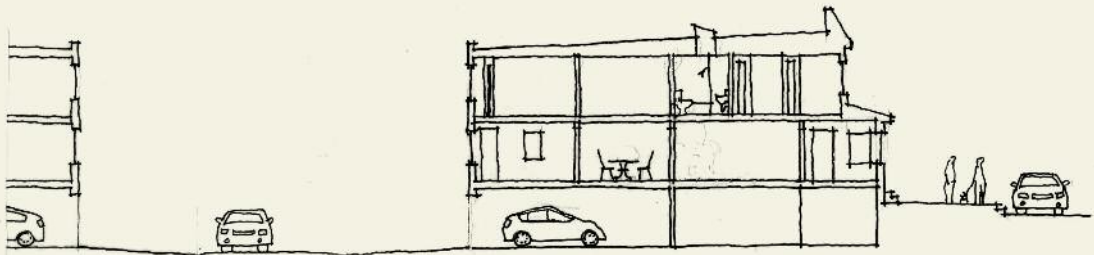

Section through a house in the Northeast with rear garage at the basement



# Inside the Rowhouse

Rowhouses have stood as witnesses to huge changes in Philadelphia's domestic life over 300 years. Just look at our bathrooms, and the amount of clothing we have, compared with our forbearers. This section discusses the specifics of living and working spaces, bedrooms, storage, and systems—plumbing, heating, air conditioning, and electrical systems.

# First Floor

How a home relates to the street and sidewalk says much about the character of a street. How a person moves from the outside of the house to the inside says much about how welcoming and inviting it is to people who live and visit there.

Many first floors of older homes have taller ceilings and a more open plan than the stories above, allowing for taller windows and better air circulation. These were the larger and more public rooms, and were grander in design and detail than some of the more utilitarian rooms upstairs. Often the kitchen is in a one story addition at the rear of the house. In a very small house, the kitchen was usually in the basement.

## Vestibule

Because we live in a climate where winters can be severe, it is very desirable to have a two-door entry between the exterior and the interior. Don't be tempted to remove the vestibule to gain floor space. You will regret it when you feel the drafts and pay your heating bills.

## Living & Dining Room

Be realistic when you plan the living room, dining room and kitchen. The rowhouse living room that is never used is a waste of valuable space. In a small rowhouse, a second floor room could function as a library or TV room, and the first floor could be devoted to an eat-in kitchen and a dining area. In a two story house, an open first floor plan can accommodate all three functions in a way well suited to casual living. Flexible room use is the hallmark of the rowhouse.

## Furniture

Because of their compact size rowhouses can be difficult to furnish. Look for sofas that are not too large, and make sure they will fit through your doorway. An over-sized chair can make a small room appear even smaller. Coffee tables can double as foot rests, and some have compartments for storage.



Top: James Oleg Kruhly + Associates Architects  
Bottom: A well lit corridor leads toward daylight,  
Atkin Olshin Schade Architects



## Lighting

If you have a dining table that needs to be relocated for special occasions, consider light fixtures on tracks or an adjustable pendant light with swag hooks. Wall sconces offer nice ambience, as do candles. Use dimmers as a way to adjust the mood, as well as save energy.

## Powder Room

The value of a toilet and sink on the first floor is immeasurable. Aside from the convenience, it may make the difference between being able to stay at home while temporarily incapacitated due to an illness or injury, and having to stay with relatives or at a convalescent home. For older residents who climb stairs with difficulty, it may mean the ability to live at home longer. A powder room can be tiny, tucked in next to a closet or, if the basement stair is elsewhere, under the main stair. An out-swinging door is often the secret to fitting in a tight space.



**Doors should be a minimum of 34" wide to allow for the use of a walker, or for a person carrying a big load. Door openings should be durable wood or metal, not drywall. Lever door handles are easier to operate than door knobs.**

**Wall-mounted handrails or bars should be securely fastened, in case someone uses them for support. Wood blocking can be installed behind drywall to reinforce the mounting.**

**Floors should be as slip-free as possible, with any uneven areas repaired. Loose rugs are always a tripping hazard, as is a level change with only a single step: people often don't see them. If you have a single step level change, especially if both levels are the same material, make sure the area is well lit, and consider calling out the edge with a contrasting color.**

**The International Building Code requires that all powder rooms or bathrooms have an exhaust fan or operable window.**

## POWDER ROOM

*These are some plans for very compact powder rooms. Swinging the door out of rather than into the room can make a huge difference. Pocket doors are another choice, though don't offer as much sound insulation. A corner toilet and corner sink can save space.*

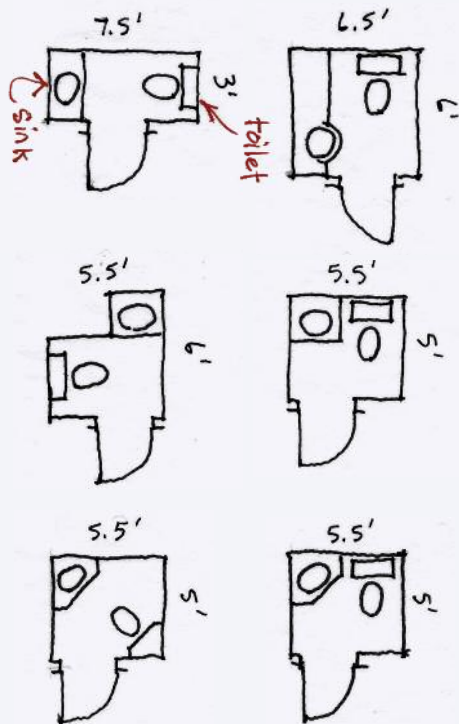

WHITEHAUS.COM



ELIEX.COM

# Kitchen & Laundry

*“A place for everything and everything in its place.”*

ISABELLA MARY BEETON, *THE BOOK OF HOUSEHOLD MANAGEMENT*, 1861

The kitchen may be the heart of the house, but it wasn't always so. It was very often in a shed added at the back or in the basement. In houses where space is tight—so often the case with rowhouses—cooking now competes for space with watching television, reading the paper, doing homework, and paying the bills. Well-organized storage is essential to keep such a multi-tasking space working smoothly.

Hundreds of magazines and books burst with the latest trends in kitchen design. Look for layouts that minimize steps (especially between sink, stove, and refrigerator) and place workspace adjacent to related fixtures and appliances. Locate cabinets to put frequently used items in easy reach.

## Cabinets

Good quality cabinets don't always command premium prices. Look for durable shelf and drawer construction, quality hardware, and wear-resistant cabinet fronts. Maximize storage by extending upper cabinets to the ceiling (be sure to have a convenient space for a compact step ladder). Pull-out shelves and drawers ease access, especially for those with disabilities. It's useful to have an open bookcase nearby, and a file drawer as well. Minimize corner cabinets; they are difficult to access and good fittings can be expensive.

## Materials

Keep materials simple and easy to clean, and as durable as you can afford. Neutral, natural materials will look better for longer. Continuing the hardwood floor into a kitchen can help tie together spaces—an extra layer of polyurethane will protect the wood in high-use areas. Tile and stone are durable but can be uncomfortable over long periods of standing. Linoleum and vinyl are sold as tile or in sheets, and if installed properly can be a great way to cover a floor more economically.



Top: Schade and Bolender Architects

Bottom: Brett Weber Architects PC



**Kitchen countertops can range in price from \$20 to \$125 per linear foot installed. The variables aside from cost are: durability, ease of cleaning, choice of colors/finish. Plastic laminate continues to be the best value for its durability, while engineered stone seems to be the most resistant to stains and heat damage.**

**TYPES: in order of cost (lowest to highest) Plastic laminate (Formica™, Wilsonart™), maple butcher block, ceramic tile, solid surfacing material (Corian™), natural stone: marble, granite, soapstone, stainless steel, engineered stone (Zodiac™, Caesarstone™, Silestone™), sealed concrete.**

## Appliances

With energy costs volatile, look for Energy Star ratings and use the yellow energy-guide stickers to choose efficient units. Take measurements of the space available when replacing an appliance, noting the degree to which appliances (especially refrigerators) project beyond the counter depth. Make sure doors of ovens, refrigerators and dishwasher don't collide with each other or other obstructions.

Finish materials surrounding a stove need to be noncombustible (tile, stainless steel). Professional-style ranges may be much larger than conventional stoves and can heat a kitchen to uncomfortable levels.

An exhaust fan vented to the exterior is required by code for the bigger ranges and for kitchens that don't have windows. Venting is important in all kitchens to remove smoke, odors, excess moisture, and reduce the deposit of grease and oils. If venting outside is not possible, a recirculating fan with a washable filter helps.



## Laundry

The laundry need not be relegated to the basement. You can locate a washer and dryer on upper floors if you set the washer in a pan with a drain to catch any overflow or leaks. New energy-efficient units use less water and are often small enough to fit beneath a kitchen counter. Stacking units save space.

Dryers must be vented directly to the exterior. Clean the ducts regularly to reduce the possibility of fire from lint build-up. To really save energy, hang your laundry up to dry outdoors or on a rack in the bathroom. Just be sure to run the bathroom exhaust while the clothes are drying.

## APPLIANCES & LIGHTING

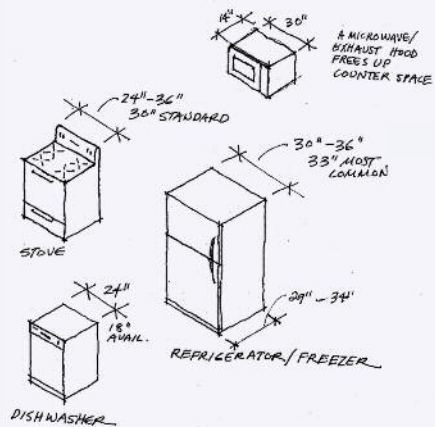

Common appliance sizes

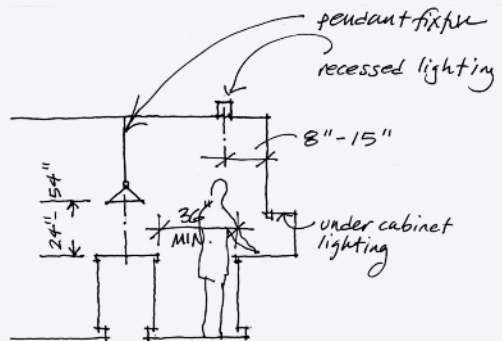

Lighting for the kitchen

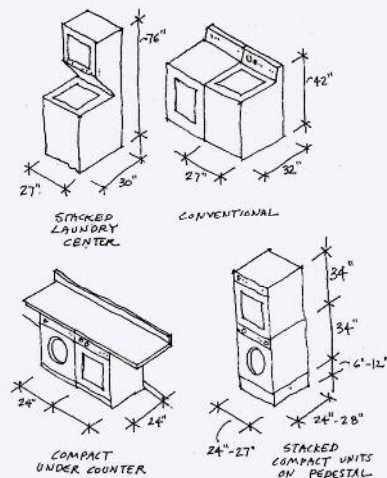

Washers and Dryers

# Stairs

A stairway with beautifully turned spindles and a gracefully curving rail is a real asset to a house, so maintaining or restoring original stairways of real craft can be well worth the effort. A beautifully made new stair can similarly become a focal point. In rowhouses, stairs seem always to take up too much space yet often feel cramped. Keep these considerations in mind when updating, replacing, or adding stairs.

Stairs are most comfortable when the treads are deep enough to accommodate almost all of our foot and when the risers are not too high. Each step in a set of stairs must have the same dimension. (In older houses, stair dimensions often vary, which is a tripping hazard and should be fixed.) A well-anchored handrail is required on at least one side of the stair and you must provide a balustrade to the side of the stair if it is open rather than enclosed by walls.

Rowhouses often have very steep staircases to minimize the space they use. But saving space entails a tradeoff: a steep stair may be difficult for those whose walking is impaired. It's also harder to stop a fall on a steep stairway. Always repair a tilting staircase, replace loose, broken or uneven treads, and repair wobbly railings.

You should always have a light fixture at the top and bottom of the stairs, which should be controlled by a switches at both ends of the stair. Easy-to-install gates (top and bottom) are necessary for families with toddlers.

## Stairway Types

A straight-run stair is the simplest and least expensive, but many houses are too small to accommodate them. A 90-degree turn, even one with just a couple of steps, may help a stair fit a tight space. A switchback stair (reversing course mid-run) may do the trick, too, but the landing will be larger.

Many small rowhouses have stairs called “winders”, which are spiral stairs that radiate around a point. They are best avoided (and are not legal in new construction or major renovations) and must be walked with care because it is easy to lose your footing on the narrow part of the tread. Also, it may be all but impossible to move large pieces of furniture up winding staircases.

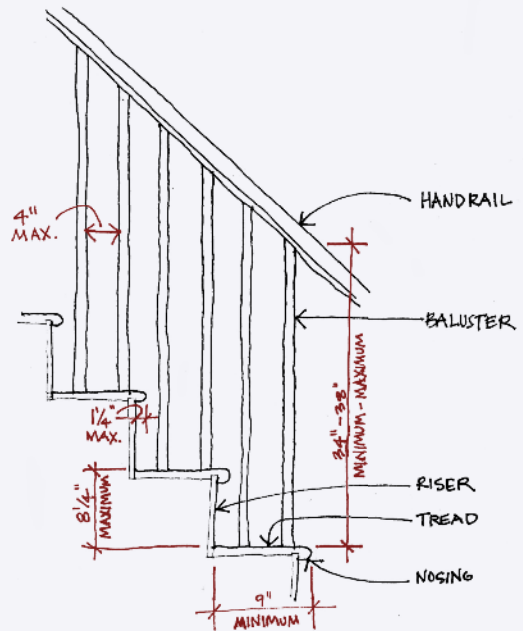

*These dimensions are determined by the building code and apply to new construction. If you have an existing stair that does not meet code, you are required to change it only when you are renovating.*

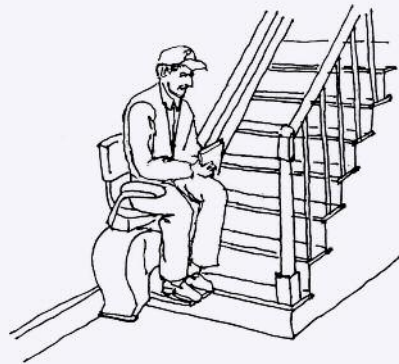

Chair Lift



For those who can't climb stairs, lifting mechanisms can often be fitted to run up the wall, keeping it free for normal usage. A small residential elevator can be installed in larger homes, but at considerable expense.



# Bedrooms & Closets

When most rowhouses were built, bedrooms were almost always shared, even if furniture all but filled the room. Owning few clothes, people got along with very small closets or freestanding wardrobes. Nowadays small bedrooms can be comfortable and feel spacious with careful attention to furniture and storage.

The bed is the largest piece of furniture in the bedroom, and can sometimes be hard to fit so always measure first. Some really large mattresses can be broken-down into two pieces. Other furniture sometimes has legs that can be removed. Bunk beds or a loft bed with a small desk save space in kids' rooms, but be aware of headroom clearance, and make sure that it has a built-in ladder for access.

## Closets

In order to hang clothes on a rod, a closet needs to be at least 24" deep. Hangers are roughly 18" wide, but most clothes flair out a bit. It is helpful to have a shelf or two above the hanging rod. In the event you have enough vertical space, you can mount two rods one above the other to hang items of short length (pants, shirts). You can build in shelves or drawers to reclaim the space a dresser would use. Clothing hooks on the back of a door or along the side of a closet can add even more storage for clothes, belts, robes, hats, and handbags.

Another space- and money-saver is to use curtains instead of closet doors: they take up much less room, are much less expensive, and can be changed like a shower curtain. Heavy fabric is recommended (canvas, velveteen), and can hang on a rod between the jambs of the closet opening.



**By code, you must be able to turn a light on when entering a room. You can wire a switch by the door to an overhead light or to a plug outlet for a lamp.**

**By law a sleeping room cannot be smaller than 7ft x 10ft, with a 7ft high ceiling. Bedrooms must have a window that opens to the exterior and it must open enough to allow a person to climb through in the event of an emergency.**

**Install lighting in a closet with care—away from stored objects, which can cause a fire. Bare light bulbs must be enclosed.**

## EGRESS & EFFICIENT FURNITURE

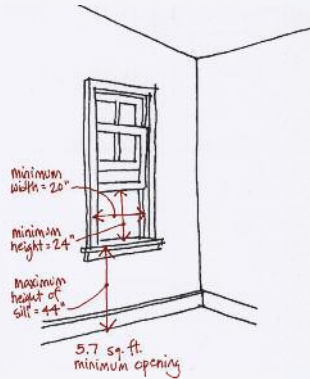

All sleeping rooms require a window that someone can crawl through.



A bunk bed, a desk, a bureau and a closet all combined in one unit.

## MATTRESSES

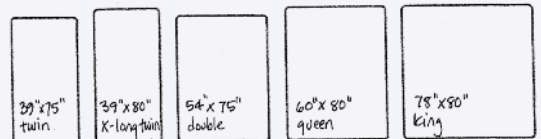

Standard mattress sizes

## CLOSETS

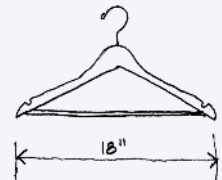

Typical hanger dimensions

A well thought out closet

# Bathrooms

Bathrooms, like kitchens, tend to cost more on a square-foot basis than any other room in the house, but you don't have to break the bank to have a functional and beautiful bathroom. More high-quality, well-designed, reasonably priced fixtures, fittings and finishes are available than ever before. A bathroom does not need to be enormous, either. It needs to be comfortable, durable and easy to clean. A good bathroom is well lit and has some storage space.

## Fixtures

Generally, classic white fixtures (sink, tub, toilet) remain in style longer than the latest fashionable hues. Color and pattern can be introduced with towels and paint, which are much easier and less expensive to replace when trends change.

No code requires that every home have a bathtub, but most realtors suggest that each house should have one. If you like to take long baths, make sure the tub is deep enough to get submerged. A deep tub can be inconvenient if you normally take showers or if mobility is impaired, so think about how you will use the bathroom before you decide which fixtures to purchase. In the tub and shower, grab bars can double as towel bars, and should be firmly attached through the wall to solid-wood blocking. Planning for grab bars is important for safety, not just for the disabled. Anti-scald shower valves are highly recommended and now required in some areas.

A pedestal sink will make a small bath appear larger, as more of the floor is visible. Many people prefer a vanity for their sink to use for storage; but they often attract clutter. Medicine cabinets and small closets are a better storage option. A sink console (sink and countertop atop a frame) is a good idea, and can be outfitted with a bar for hanging towels. Make sure the pedestal or console has enough flat surface for soap, a drinking cup, etc. Two sinks are nice for two people if you have the room, but not necessary. A shut-off valve at each fixture is preferred, but some plumbers will only install a single shutoff for a whole bath in one location (normally in the basement). A ball valve for the shut-off offers the least trouble

over time. A “trouble door” is often found behind the bathtub controls, making it easy for a plumber to repair or replace faulty plumbing.

New faucets and toilets are made to conserve water usage. A well-designed efficient fixture will not noticeably affect the water pressure.

How to decide which toilet to buy? New toilets are available with a higher seat than usual, which makes them easier for people with mobility problems to use. Two-piece toilets are usually less expensive than one piece models, and use gravity to flush rather than mechanics. Some new toilets even offer a “dual flush” option, a great water saver.

## Finishes

There are thousands of choices in ceramic tile, hundreds in stone and more engineered stone and solid surfacing materials appear each year. Be sure that materials are easy to clean, and countertops should not be porous or that will make them vulnerable to stains. Large tiles minimize grout joints which tend to be difficult to keep clean. Install tile on the walls to a height of four feet, especially around toilets.

Polished chrome is the most common and least expensive finish for faucets. Beware of special finishes as they can be expensive or difficult to maintain.



**Bathroom floors need to have some texture so they are not slippery when dry or wet.**

**All bathrooms are required to have either a window that opens, or an exhaust fan. Without proper ventilation, the humidity in a bathroom can promote the growth of mold and mildew.**

## LAYOUTS

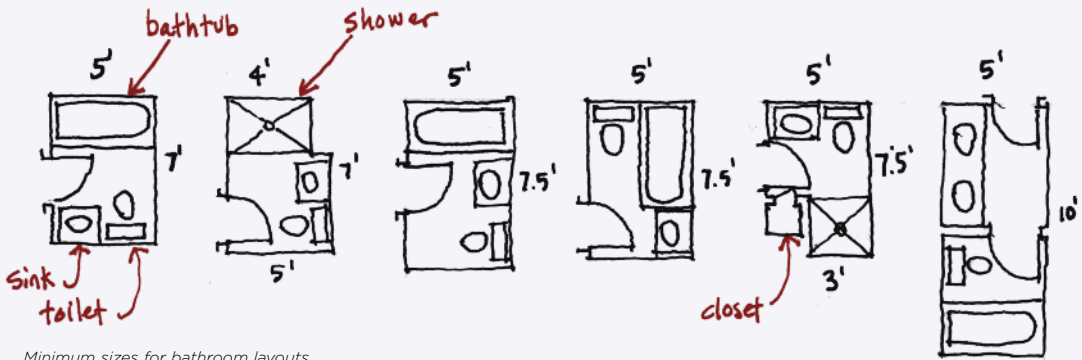

Minimum sizes for bathroom layouts

## SHOWER & SINKS

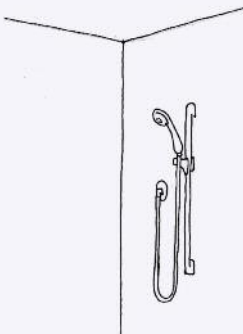

Adjustable hand-held shower

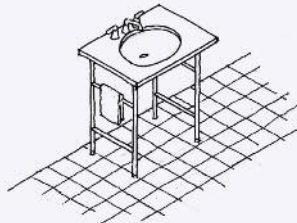

Console sink

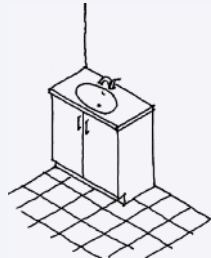

Vanity Sink

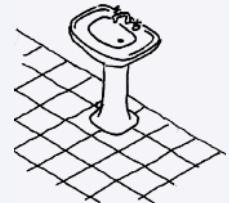

Pedestal Sink

Another good idea in a tub/shower is a hand held shower. These are attached to a vertical bar, and so can be adjusted for one's individual height. They can be used as the main shower head, or with a diverter, in addition to the shower head. Not only are they nice for showering, but they are useful for cleaning the tub and walls.

## ACCESSORIES



This is a "hotel" rack, great for towels over the toilet

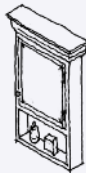

A surface-mounted medicine can hold supplies

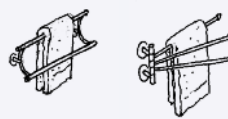

Special towel bars are able to hold more than the standard type

When you're tight for space, a sturdy hook can take the place of a towel bar. Make sure all accessories are firmly attached to framing or blocking behind the wall surface. Shelves can accommodate extra towels and supplies. Shower curtains are much less expensive and far easier to keep clean than shower doors. Some medicine cabinets are as deep as 6" so they can accommodate more, even spare rolls of toilet tissue.

# Flexible Spaces

## The “Not So Big House”

Great sources of inspiration for rowhouse occupants are found in “The Not So Big House” (Taunton Press, 1998) and other books by Sarah Susanka, a Minneapolis architect. Rowhouse owners may not have a choice but to use small spaces efficiently. Even if you have more space than you need, you can still make it work harder.

## Overlapping Uses

Does your living room look perfect but is never used? Is your dining room used only on special occasions and is otherwise off limits? You can make rooms do double duty. With games and the TV stored behind cabinet doors, an informal family room can become a handsome space for big meals and entertaining. Everyone likes to spend time in the kitchen, so there’s no reason not to open it to other rooms. If you want a formal space to receive guests but never use a big living room, consider creating a modest parlor at the front door (many rowhouses have these rooms anyway). With thoughtfully chosen cabinets and shelves, and a sofa bed, a sewing or project room can quickly be transformed into an occasional guest bedroom.

## Home Office

You can convert a bedroom to a home office—whether full or part-time—easier than ever today, with the wide selection of furniture designed with those who work at home in mind. Even a wide closet with bi-fold doors can become an office space in a small house, and can disappear (with the mess on your desk intact) when guests arrive. To work at home full-time generally means you’ll need to devote a room to work, where valuable documents can be kept away from prying childrens’ hands, and the door closed to screen disturbances. If a separate room isn’t possible, you can place a closable desk in almost any available corner or alcove—although you will want to consider the proximity to electrical outlets (one is often not enough), a telephone outlet and internet service. You will be glad for a window, especially one with a view, but the basement or the windowless center of the house may also be the place for a home office when the needs for storage and work surfaces trump other considerations.

## HOME OFFICE

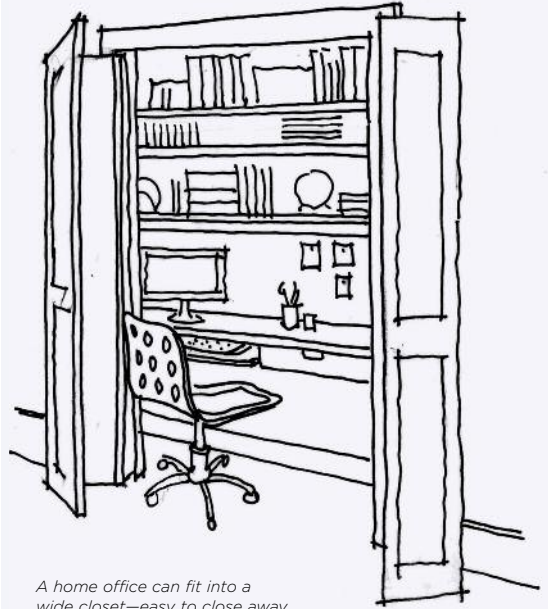

*A home office can fit into a wide closet—easy to close away.*



# Basements

## Walls & Foundations

Since the foundations and basement walls must hold up your entire house, you should remedy any structural problems as soon as possible. Signs of trouble are significant cracks, misalignments, settling, and bulges. Repair eroded masonry joints. If you can see the joists overhead (the thick wood framing that holds up the floor), confirm that they have not been damaged by rot or termites.

## Water in the Basement

Groundwater problems can often be solved by fixing faulty outside drainage. (See Gutters and Downspouts and Stormwater Management). If you cannot find the source, consult a professional. Few walls can be water-proofed from the inside, but a sump pump (which sits in a water-collecting pit) can remove heavy seepage.

Flooding is another matter. If you have unused toilets, sinks or floor drains in the basement, have them removed and blocked so that overloaded sewers cannot back up into them. Repeated flooding amongst several houses in a neighborhood usually indicates a sewer problem that must be addressed by the Water Department. A back-flow preventer valve can be installed to keep sewage from coming up through your piping. For general dampness, a portable dehumidifier can be very effective, and it only uses as much power as a light bulb.

## Finished Basements

Often basements do not have high enough ceilings to accommodate normal living spaces, but when the bottom of the floor joists are 7 ft high or higher you may want to consider having a playroom or home office downstairs. Lighting may be installed between floor joists (don't remove the cross bracing); an electrician can advise on types that won't cause a fire hazard. Separate the finished areas of the basement from the utility areas (furnace, water heater, meters) with partitions and doors. Keep flooring simple and able to resist damage from the occasional leaking pipe.



**Mold can grow on many indoor surfaces, including carpet, cloth, drywall and insulation. Many molds are unsightly, but harmless. Others can cause serious health problems, from triggering symptoms of asthma to deadly conditions. Promptly repair conditions that create dampness, then clean and dry wet building materials within 48 hours to prevent mold growth. If water has stood for a time, finished wall surfaces may have to be removed to fully treat and dry the walls behind. Electrical wires and outlets may have to be replaced.**

**Radon is an odorless, colorless gas that occurs naturally in the soil, and can cause serious illness. It usually enters a house through the basement. The federal Environmental Protection Agency (EPA) recommends that all houses be tested for radon even though Philadelphia is listed in the lowest incidence category. Remedies can be inexpensive but usually require professional help. (See Resources p. 46)**

**Carbon monoxide is an odorless, colorless toxic gas, often released by poorly maintained appliances, like furnaces or water heaters. The first line of defense is to regularly maintain these appliances. Carbon monoxide detectors (some in combination with smoke detectors) are widely available.**

**You cannot use a basement for a bedroom unless the way out is adequate in case of fire (no ladders) and you can install windows of the same type required in other bedrooms for egress.**

**It is possible to excavate the basement to get more ceiling height, but you cannot expose footings or dig lower than the basement level of adjoining houses without providing adequate structural support. See Structural Issues p.36.**



Basement egress window

# Interior Materials

## Floors

Most floors above the basement are laid on top of subflooring, which spans across the joists below. Hardwood flooring is the most common finish material found in the rowhouse; often with decorative borders. When possible, hardwood floors should be repaired and refinished rather than replaced. A tongue and groove wood floor is typically 5/8" to 3/4" thick, and can be refinished. A "face-nailed" wood floor is only 5/16" thick, and needs to be refinished carefully as it is very thin. A darker wood stain can help even out discolored patches that aren't removed by sanding.

Carpet can be a less expensive way to cover the subfloor; a tightly looped weave or a short pile will last longer and will not retain as much dust. A sturdy flat pad beneath makes a thin carpet more comfortable.

## Walls & Ceilings

Many older homes have interior partitions made of plaster applied to wood lath. Over time, plaster becomes loose and falls off when the "keys" break loose from the lath.

When repairing cracks or holes, it is best to preserve the older material and patch it with new plaster. New partitions are usually built with drywall (also known as sheetrock or gypsum wallboard), which is much less expensive than applying 2-3 coats of wet plaster on lath. A good compromise is skim-coating the drywall with a thin layer of plaster veneer to match the texture of adjacent walls. Decorative plaster mouldings should be repaired or replaced.

## Trim

Wood is milled into different shapes to finish off a room: to cover the joint between the floor and the wall, the wall and the ceiling, or to transition from a window or door to the adjacent wall. The first floor of most houses often has heavier and thicker trim than upper floors. When possible, preserve and re-use old trim to maintain the original character of a room. New mouldings can be made to match the old ones for not much more than thinner ready-made trim available at home improvement stores.

## Doors

Interior doors were often made like cabinet furniture, a frame with panels in various patterns, and were typically more ornate on the lower, more public, floors of the house. Re-finish and re-use old doors rather than replace them when possible. A good solid wood door can reduce sound transmission as well as look beautiful. Flush (flat) and hollow core doors are less expensive but usually lack character and heft.

Many companies make new hardware that matches older styles, and finishes such as an antiqued brass will complement older hardware rather than looking too new. Look for solid brass rather than plated steel for longevity.



Left: Exposed wood lath on old plaster wall

Center: Moulded plaster ceiling medallion

Right: Installing a composite ceiling medallion

## Paint

Repainting is one of the easiest and least expensive ways to transform a room. Proper preparation of the surface before painting is essential to a long-lasting paint job. Older homes often have paint that was made with lead, and should be tested before being scraped off. Cracks and holes should be repaired and sanded. Darker colors often require additional coats to cover a light base. Primer can be tinted to assist in the transition. As with the exterior paint colors, most manufacturers have assembled palettes of coordinated colors to assist in selection. It is nearly impossible to select a color from a small paint chip. Buy a small amount (some companies even have sample pots available) apply a 2 ft by 2 ft swatch of color on various walls to see how the colors look in various lighting conditions (night/day, fluorescent/incandescent) before deciding on the final scheme. Light colored or white ceilings will make a room feel taller. Flat paint will be the most forgiving of irregular surfaces.

## Wallpaper

Old houses often have many layers of wallpaper, sometimes under layers of paint. Remove wallpaper carefully to preserve the wall beneath and minimize prep work. New wallpaper can be installed by the skilled homeowner with some practice.



**If a material smells toxic, it usually is. Look for materials that have low VOC's to avoid adding harmful out-gassing of potentially hazardous materials.**

**Keep extra paint, wallpaper, tile, etc for future repairs. Label it clearly so you remember when and where it was used.**

## DOORS

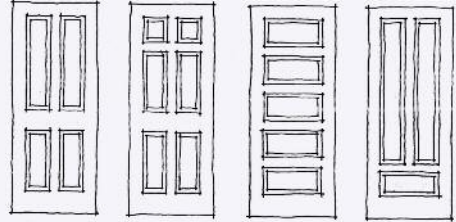

*Solid wood raised panel doors*

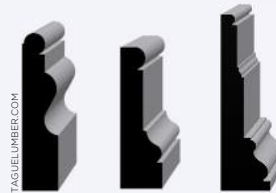

*Wood door casing moulding*

# Mechanical Systems

## Heating, Ventilation & Air Conditioning (HVAC)

Most rowhouses are heated by a boiler or a furnace that is fueled by natural gas or home heating oil.

- A boiler heats water, or sometimes makes steam, that circulates through radiators.
- A furnace includes a fan, and circulates warm air through ducts into the rooms through ceiling, wall, or floor registers. Some furnaces include a cooling unit for central air conditioning that may run through separate ducts located near the ceiling.
- A heat pump can provide heating and air conditioning.

Central air conditioning requires an outdoor condensing unit, which needs to be located where the noise and heat can dissipate. It cools liquid, which enters the indoor air handler through thin insulated tubes. As air blows across the cold coils, water condenses and must be drained or collected in a condensate pan.

Any kind of air conditioning consumes a great deal of electricity, so the best way to keep your bills down is to put the thermostat to the warmest temperature you find comfortable. In winter, setting the furnace thermostat a few degrees cooler will also pay off in substantial savings during the heating season.

Window air conditioning units are inexpensive to buy, but tend to be more expensive to operate than central air conditioning. Make sure the units are securely installed, and check to be sure condensate drains or dissipates into the air. If it is collecting on the windowsill or running down the wall, it can do costly damage. (see p. 10) You will save heat energy by removing the air conditioner during winter months, but if that's not possible, an insulated cover will cut drafts.



Left: Insulating air conditioner cover

Right: Ceiling fan



**A ceiling fan is a low-cost way of keeping cool. A fan will not actually reduce the temperature, but the movement of air has a “wind chill” effect that can really make a difference on a hot day. Hang the fan at least one foot below the ceiling, 7ft above the floor, and at least 2ft from the nearest wall. For rooms up to 144 sq. ft., a blade span of 42” to 44” is recommended.**

**In the event of a fire, a smoke alarm can save your life and those of your loved ones. They are a very important means of preventing house fire fatalities by providing an early warning signal—so you and your family can escape. Install smoke alarms on every level of your home, including the basement. For renovations that require a building permit an electrician will have to install a smoke detector wired into the electrical system of the house rather than relying on a battery. Battery-operated smoke detectors work reliably; but batteries should be checked monthly and replaced twice a year (easier to remember if you do it on the days you set your clocks for Daylight Savings Time).**

**Home security systems need not be expensive but should be installed by professionals. The most effective systems tie into both the alarm company and the fire or police departments (registration fee required). Let your neighbors know when you will be away; they'll keep an eye on your home and you can give them information to turn off the alarm if it goes off in error.**



## Plumbing

Plumbing for rowhouses does not vary significantly from that of other older housing types, however because space is limited, plumbers often would cut access holes through wood joists to avoid exposing pipes. When replacing fixtures, supply and waste lines may be disturbed by the demolition process. Lead piping should always be replaced if found. While the Philadelphia Plumbing Code allows new supply lines to be made of reinforced plastic piping, most plumbers recommend installing copper piping. Likewise with waste lines: PVC piping is allowable, but cast iron is more likely to absorb the sound of rushing water—in a small house this can be quite noticeable. Insulate hot water piping where it is accessible. Tankless or on-demand water heaters are becoming popular, but they have a higher upfront cost and require a sizable gas line and proper venting. It is important not to oversize the water heater so you are not warming water you never need.

## Electricity & Lighting

Many older homes have low capacity electric service. If you plan to increase the electrical load when renovating, consult an electrician and PECO regarding upgrading your service. Electric dryers, electric stoves, and central air conditioning systems are examples of appliances that draw a significant amount of power. The circuit breaker or fuse box exists to prevent overloaded wires from causing fires. If a circuit or fuse trips frequently, it means that you need to remove the source of the overload or rewire. Never simply replace a breaker or fuse with one of greater capacity, as it could lead to a deadly fire.

Porcelain knob and tube or fabric wrapped wiring can still be found in some rowhouses. While not intrinsically dangerous, it should be replaced when renovating as it is likely to be in poor condition and is not allowed to be installed by code today. To avoid electric shocks, outlets should be grounded. You can test them yourself with an inexpensive device from a home store. Any outlets near a water source (as in a bathroom or kitchen) need to be the type that contains a re-setting circuit breaker. It will keep you from getting shocked if you touch the outlet when you are also touching water.

Because they are long and narrow, rowhouses can be dark, especially on the lower floors. Add more lighting to the areas at the center of the house, and keep wall colors light. Consider installing skylights at the upper floors, especially above rooms with no windows.



*Left: Sink shut-off valve*

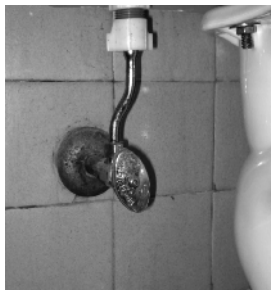

*Center: Toilet shut-off valve*



*Right: Reproduction wall sconce*

# Structural Considerations

One of the beauties of the Philadelphia rowhouse is the simplicity of its structure; it is easy to understand how the parts work together.

## Foundations

The house sits on foundations that are below grade. If foundation walls or piers have tilted, heaved or cracked, they may not have been sunk far enough below the surface and cycles of winter freezing and thawing have displaced them. An engineer must propose remedies to avoid settling or collapse. Tilted, bulging or badly cracked basement walls suggest foundation problems that merit immediate remediation.

## Floor Structures

Typically, wood joists span from party wall to party wall and rest in pockets in side walls. One of the most common structural problems is when the joists rot where they rest in those pockets.

## Walls

Most rowhouses 16ft wide or less are supported by their side walls. Wider houses (or deep ones) may have intermediate walls that bear the weight of floors on piers underneath the house. These are called structural or bearing walls. Only with expert advice should you consider altering any structural wall. You will have to add support in other areas.

In older homes, party walls between rowhouses are usually made from bricks. For stability, and to keep fire from spreading, party walls should have two or more wythes (horizontal layers) of brick, in good

condition and lacking air gaps that could spread fire or smoke. (Other code-acceptable noncombustible materials can be used, as long as the construction is rated to achieve the minimum required fire separation). In older homes, party walls do not always extend up to the roof. Any openings at party walls should be filled to maintain the fire separation from top to bottom. Some party walls support the floor and roof, and no changes should be made that would reduce the strength of the wall. Consulting a professional architect or engineer is a must.

The exterior masonry walls of some rowhouses might bulge or tilt noticeably over time. This condition—caused by settling or pressure from an adjacent house—among other culprits—can be dangerous. If a wall is tilting outward (use a plumb bob or weighted fishing line to check), call an engineer. Fixes can often be relatively inexpensive, and much less expensive than reconstruction. Water penetration can erode the solidity of the joist-to-masonry connection. This condition must be corrected, either with “star bolts” or chemical anchors.

## Roof Structure

As discussed on p. 16, the roof is the most vulnerable part of the house. Fix leaks promptly. If you suspect your house has been neglected, have the roof structure inspected in case rafters (and attic floor joists if you have them) have rotted.

If roof rafters run front to back it is tempting to remove the flat joists that tie them together to make more headroom. Don't; these joists are an integral part of the roof-support system.

### HOME OFFICE

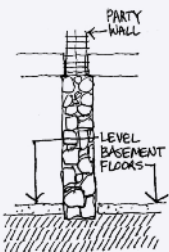

Most rowhouses have basements at the same level. Do not excavate your basement without professional help or you will undermine and weaken the party wall.

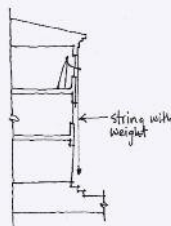

Drop a plumb bob to see if your wall is straight.

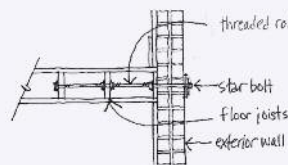

Star bolts tie back a bulging wall.

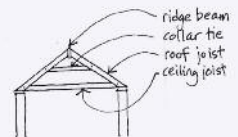

Roof cross ties



# Your Rowhouse

What if a particular rowhouse is too small for your lifestyle? What if it is too large? How can you make the most of the space available? The process of making changes to a rowhouse can be daunting, but it need not be mysterious. This section provides two case studies of actual Philadelphia rowhouse projects. We also include advice about maintaining your home followed by some compelling ideas for renovations. There is information on building permits, working with professionals, and some very useful resources.

# The House is Too Small — A Case Study

Do you often find yourself wishing for just one more room? Sometimes you need a guest room for in-laws so they can stay overnight at Thanksgiving. Other times it is a project room, where you can leave all of your stuff out without having to clear it off the kitchen table so you can eat dinner. Some people just yearn for another 12 inches of shelf space in the kitchen, or a linen closet. Many people want to stay in their homes, but need to find some more space. Deteriorating additions can be removed and rebuilt, adding stories and decks above. Making more efficient ways of storing the stuff you can't part with can be life changing.

This is the house of a homeowner who wanted to enlarge her kitchen, and add a second floor bath above it. The house had a small two story portion on the rear with a small roof deck. The kitchen was small and the appliances and cabinets needed to be upgraded. With a wish list created by the homeowner, the architect proposed to remove the old addition, create a wider opening to a larger new kitchen addition, and create a master bedroom suite above. The contractor inserted a steel beam to open up the kitchen up to the dining area. New French doors connect the kitchen to a small back yard. The second floor has a large bedroom looking out at the rear yard, with a bathroom and



1st Floor, before and after, Schade and Bolender Architects

office area; both lit from new skylights. The old third floor bath was upgraded for the master suite but stayed in the same configuration. The new roof deck is more spacious and also provides a screened area for the air conditioning units.



**If you are looking to add onto your house, you will need to obtain a Zoning Permit and a Building Permit (see p. 44).**

## BEFORE & AFTER

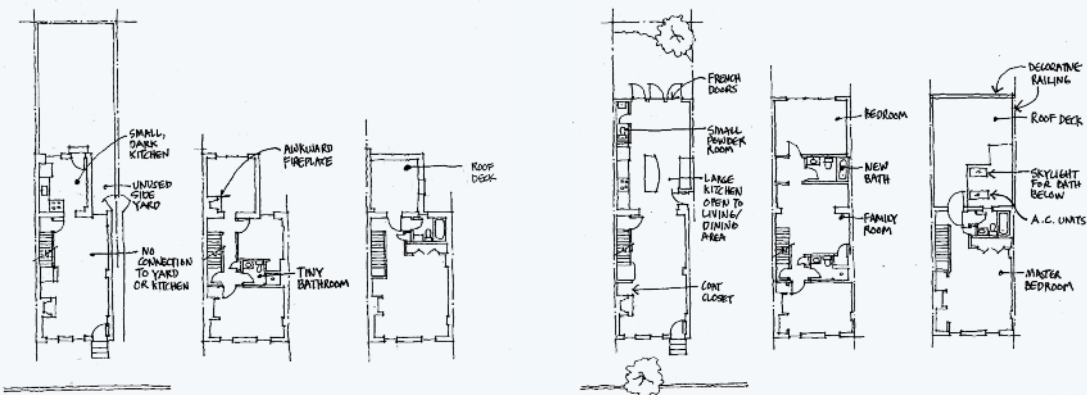

1st floor, 2nd floor, 3rd floor, before

1st floor, 2nd floor, 3rd floor, after

# The House is Too Large — A Case Study

It seems a bit odd to think that some houses are actually too large for their occupants. In fact some rowhouses built in Philadelphia are much larger than any family today requires. These houses were built to accommodate much larger families, often with live-in cooks, maids, and chauffeurs. Many of those large houses have been subdivided into separate apartments or condominiums to accommodate smaller families or to provide student housing. This is the story of the transformation of a block of architecturally important houses in North Philadelphia; from vacant and abandoned buildings to newly renovated homes for first time homeowners. Both sides of a whole block in North Philadelphia were designed by architect Willis Hale in the 1870s. They were saved by Project H.O.M.E., a non-profit agency committed to ending homelessness.

Neighbors on the block of 1900 North 23rd Street were tired of seeing the houses around them sit vacant and driving the decline of the rest of the street. They reached out to Project H.O.M.E. for help. After lengthy negotiations to acquire the properties, Project H.O.M.E.'s Project Manager Jill Roberts and architect Brian Kuhns of Kramer/Marks Architects developed a plan to reduce the size of the grand houses from 2,500 sq ft to 1,300 sq ft, still ample space to provide for three bedrooms and 1 1/2 baths. The rear ells of the houses were removed. In the bargain, a back yard was gained, and planted to absorb a good share of storm water. The houses were rehabilitated with environmentally sustainable materials, and the façades were carefully restored.



Top row: Front elevation, before and after  
Bottom row: Rear elevation, before and nearly complete

## BEFORE & AFTER

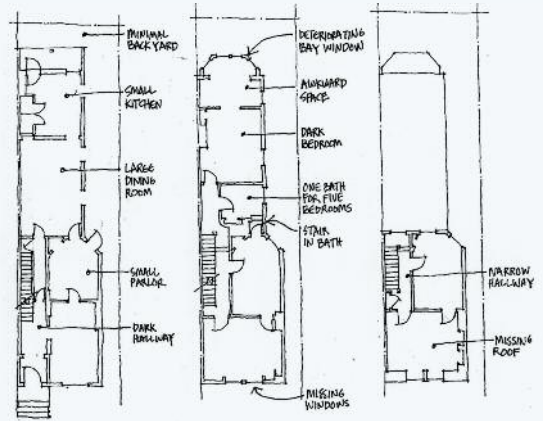

1st floor, 2nd floor, 3rd floor, before

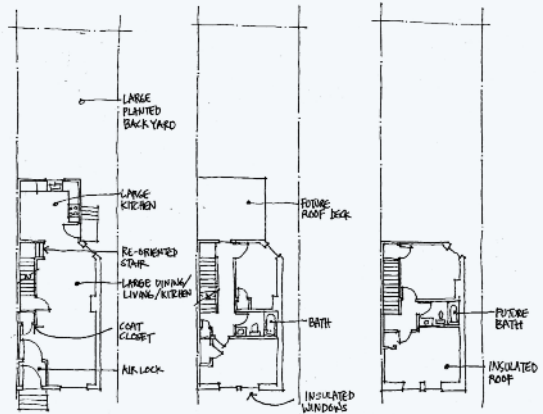

1st floor, 2nd floor, 3rd floor, after



# Maintaining A Rowhouse

Maintaining your home is very important to keep it safe, working well and to preserve its value. The easiest way to keep up with maintenance is to make a chart showing dates for various services that need to be performed. Keep all manuals, repair bills and important phone numbers with the chart. Perform repairs to infrastructure and equipment quickly to prevent further damage or unsafe and inefficient operation. Here are some basic maintenance tasks to keep your rowhouse in “working order”.

## Exterior

- Consider removing paint on exterior masonry which can trap moisture inside and cause damage
- Watch for water staining on walls, look for rot in exposed wooden members
- Check masonry and joints, stucco and paint for signs of cracking and peeling
- Clear the small weep holes near the base of a brick wall so that moisture can drain
- Look for signs of animal or insect damage or droppings around cornice and in vents
- Clean gutters regularly to make sure they drain, look for signs of clogged downspouts or gutters during heavy rain
- Have a professional check roof surface for blistering and cracking at flashing and chimney caps
- Hire a chimney sweep to clean and inspect chimneys once a year for animal nests and soot build up
- Repair cracks in sidewalks and steps
- Trim back all plants seasonally to keep them from attaching themselves to the house
- Call PECO to trim trees that are touching electrical wires: 1-800-494-4000

## Interior

- Maintain all appliances and household equipment such as furnaces, water heaters, humidifiers, air conditioners etc. as described in owner’s manuals
- Vacuum refrigerator coils and replace gasketing that is not sealing properly
- Watch for water stains on all surfaces
- Wiggle stair balustrade to test for sturdiness and repair any loose members
- Check for adequate ventilation in all rooms to keep air circulating, look for signs of mildew in wet areas
- Test smoke and carbon monoxide detectors on a regular schedule and replace batteries twice a year
- Have a fire extinguisher on each floor and know how to use it.
- Have all the fire extinguishers recharged and inspected as recommended

## Plumbing

- Know where the shut-off valves are
- Clear drains that discharge too slowly as this may indicate a clog
- Check for leaks; listen for any running water sounds while all valves are turned off
- Unscrew shower head and rinse out debris periodically
- Replace any cracked or hollow sounding tiles in kitchens and bathrooms, caulk missing grout to prevent water penetration
- Check all vents, especially at the dryer, so they are free of dust and blockages, and have no tears
- Check and replace cracked or brittle washer hoses
- Inspect water heater inside for rust and clean out debris annually by draining the tank as described in the owner’s manual

## Electrical

- Look inside electrical panel to check for scorch marks
- With power off, secure any loose receptacles and outlet covers
- Test grounded outlets regularly by pushing the “test” and “reset” buttons

## Heating & Cooling Systems

- Schedule regular furnace and air conditioner maintenance
- Change or clean filters regularly
- Check all hose connections for leaks and make sure condensate tubes are draining freely
- Brush or vacuum radiators, baseboard heating units or forced-air heating vents every three months during the heating season
- Keep a 12-inch area around registers clear of any objects
- Check area around radiators for signs of leaking
- Maintain clearance around condensing units for maximum efficiency

## Energy Saving Measures

For every dollar the typical family spends on home energy, almost half goes to heating the home. And for every one degree a thermostat is turned down, heating costs are reduced by 3 percent—a good reason to put a sweater on first and keep the thermostat set at the lowest level that is comfortable. A starting place is 68 degrees or lower in the day and 55 degrees or lower at night. Old thermostats are not always accurate, and a heat anticipating or electronic thermostat is worth the modest cost. Thermostats with timers can lower heat while you are away at work, for example, turning it up to normal just before your return. Always turn down the heat if you leave the house for more than an hour.

- Replace incandescent bulbs with compact fluorescent ones, more expensive to buy but they cost much less to run and last longer
- Turn off lights you don't need
- Shade south- and west-facing windows during the hottest parts of the day with blinds or drapery
- Group cooking, showers and dryer loads if you can, it is more efficient than spacing them out over the day
- Feel for drafts around windows and doors and caulk any cracks where cold air seeps in or replace weather stripping. Pulley holes on old double-hung windows can be taped over to reduce drafts
- Keep fireplace dampers or glass doors closed when not in use.

## How Much Can You Do Yourself?

This manual is intended to provide rowhouse owners who are not building experts with practical advice about taking care of their homes. Some projects look simple at the outset, but if something unanticipated happens, you need to call in a contractor to put your house back together. Remember that your time has value as well, and sometimes it just makes more sense to call in a professional even if you think you can do it yourself.

### Do-It-Yourself Projects:

- changing filters
- installing weatherstripping
- replacing a screen
- painting

### Projects Better Left to the Pros:

- masonry cleaning and repair
- re-pointing
- roof repair or replacement
- structural repairs
- installation of through the wall or roof exhaust fans
- floor refinishing, electrical and plumbing work



*A renovation underway in Gray's Ferry*

# Renovations & Additions

More complex projects require the help of a professional. The following are some of the people who can provide you with expert advice.

## Contractor

General contractors manage the budget and schedule for a project and hire subcontractors in specific areas of expertise (plumber, tilesetter, etc)

- Only licensed contractors are allowed to work on projects that require a building permit
- Angie's List is an online subscription service with detailed recommendations for home repair services in your area.
- Seek recommendations from friends and neighbors.

## Architect

An architect is the one professional with the training, experience, and vision to guide clients through the entire design and construction process. Only an individual with a state-issued license to practice architecture may use the title "architect".

- Many local architects are members of the American Institute of Architects, which provides an index of professionals who work with homeowners to renovate their rowhouses at [www.aiaphiladelphia.org/find](http://www.aiaphiladelphia.org/find). Not all architects are members of the AIA, and can be found in the Yellow Pages or on-line.
- A designer or interior decorator will be useful when you need help finding furniture, window treatments, and selecting a color scheme for non-structural improvements to your home.

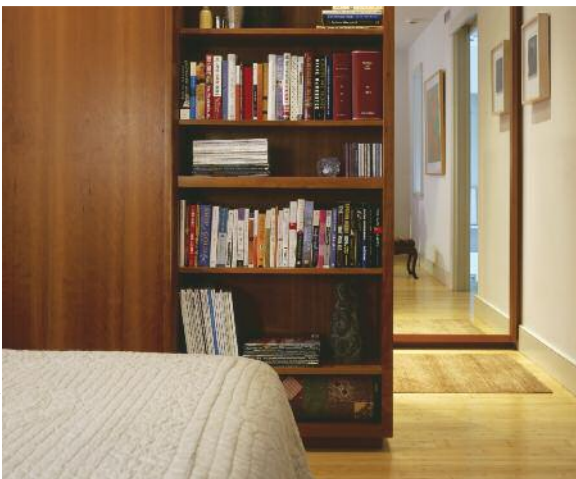

Clockwise from top left: Interface Studio, LLC; QB3 Architects, LLC; WeberandCompany Architects; BFive Studio

JEFFREY TOTARO/ESTO

HALKIN PHOTOGRAPHY, LLC

HALKIN PHOTOGRAPHY, LLC

## Landscape Architect

- A professional who holds a degree in landscape architecture, which involves training in horticulture, landscape design and planning.

## Engineer

- A licensed professional with education and certification in a particular area (structural, mechanical, etc).  
[www.pacode.com/secure/data/049/chapter37/s37.31.html](http://www.pacode.com/secure/data/049/chapter37/s37.31.html)
- Other design professionals may offer useful advice, but may not call themselves architects or engineers without state licensure.

## Keys to Success When Working with Professionals

- Know what you want, express your wishes clearly, ask for clarifications of things you don't understand
- Have a realistic budget, as well as a 10-15 percent contingency fund. The unknown inevitably appears when renovating old houses.
- Interview several architects and builders before committing to working with them. Check references, visit completed projects.
- Sign a contract that clearly defines the scope of work for the professional and a payment schedule.
- Protect areas not affected by construction, or for big jobs, move out for the messiest phases of work.

## Pitfalls to Avoid When Working with Professionals

- Don't try to be your own general contractor.
- Don't micro-manage, don't substitute your judgment for a professional's.
- Don't work with relatives or friends—business disagreements often become personal.
- Don't work without a written contract.
- Don't put down more than a 20 percent deposit before work starts.
- Don't release more than 95 percent of the total cost before work is complete to your satisfaction.



HALKIN PHOTOGRAPHY, LLC



HALKIN PHOTOGRAPHY, LLC



HALKIN PHOTOGRAPHY, LLC



GREGORY BENSON PHOTOGRAPHY



HALKIN PHOTOGRAPHY, LLC

Top to bottom: QB3 Architects, LLC; Kass & Associates; Brett Weber Architects PC; James Oleg Kruhly & Associates; Atkin Olshin Schade Architects



# Permits And Codes

Building codes have been developed to assure that structures are built well and are safe for occupancy. Zoning codes are written to regulate where certain types of building uses should be located (separating residential from industrial and commercial uses, for example), and what shape the buildings should take, specifying maximum height and area, distances from property lines and similar criteria. The Zoning Code also regulates parking. The requirements of both codes are legally binding.

In Philadelphia, a building permit is required for new construction, additions, alterations, demolitions, and some repairs. Contractors can obtain a permit if they are licensed by the City. Otherwise, the homeowner will be responsible for obtaining the permit and making sure the project is completed according to the permit—expertise you may not have.

For alterations costing \$10,000 or more, drawings of proposed construction and additions must be submitted with the seal or stamp of a licensed architect or engineer, see p. 42

Construction in Philadelphia must comply with the International Code Council's International Residential Code, published every three years, and local amendments which are available at [www.phila.gov/LI/codes/BuildingCode2007.pdf](http://www.phila.gov/LI/codes/BuildingCode2007.pdf).

The Philadelphia Zoning Code can be downloaded from the City of Philadelphia website: [www.amlegal.com/library/pa/philadelphia.shtml](http://www.amlegal.com/library/pa/philadelphia.shtml).

To find what how your home is classified, find your address on the Zoning maps visible at <http://citymaps.phila.gov/Zoning/>

The City of Philadelphia has recently streamlined the permit process for homeowners. Many questions you have may have can be answered by visiting <http://webapps.phila.gov/li/>. Permits are obtained at Licenses and Inspections (L&I) on the Concourse Level of the Municipal Services Building.

Many neighborhood civic organizations can advise you on what to prepare to apply for a building permit. Some keep a list of recommended contractors. If your work requires a zoning variance, consult your neighborhood civic organization, which may have

a review committee or offer assistance. A new Zoning Code Commission is currently reviewing the Zoning Code and making recommendations for its reform and change. Visit [www.zoningmatters.org](http://www.zoningmatters.org)

Some permits can be obtained online and do not require the submission of drawings: roof coverings, window replacement in existing openings, porch floor replacement and nonstructural interior demolition. (If you don't know what's structural—meaning it holds up your house—and what's not, seek professional assistance before applying for the permit.) These EZ Permits or WebPermits can be obtained online at the L&I website.

The National Park Service has a series of technical publications and useful preservation briefs, some of which are free, at [www.nps.gov/history/hps/tps/technotes/tmhome.htm](http://www.nps.gov/history/hps/tps/technotes/tmhome.htm).



**HISTORIC PROPERTIES:** Altering historically designated structures requires pre-authorization and a different approval process. Check to see if your property is listed on the City's Historical Register before beginning work: [www.phila.gov/historical/index.html](http://www.phila.gov/historical/index.html), 215-686-7660

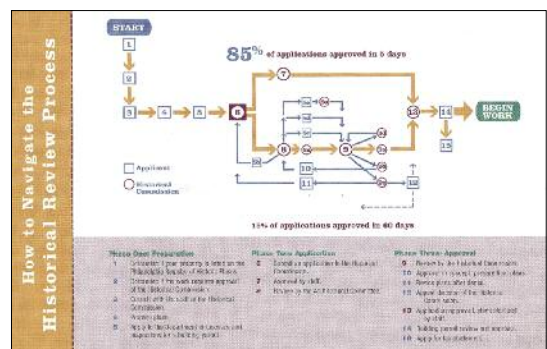

The Preservation Alliance of Greater Philadelphia has produced "How to Navigate the Historical Review Process in Philadelphia; A Guide for Property Owners" which you can download at [www.preservationalliance.com/publications/CitizensGuide\\_updated.pdf](http://www.preservationalliance.com/publications/CitizensGuide_updated.pdf)



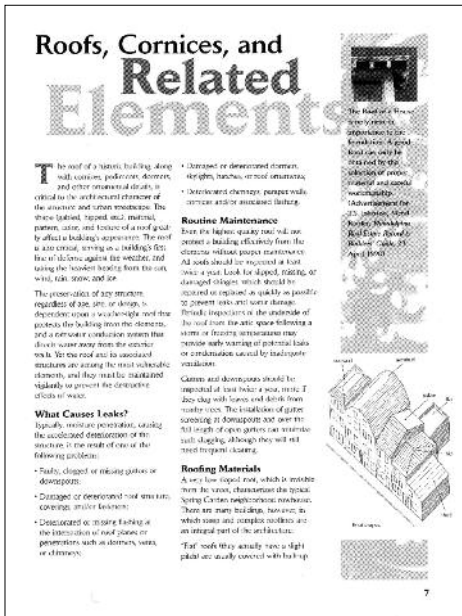
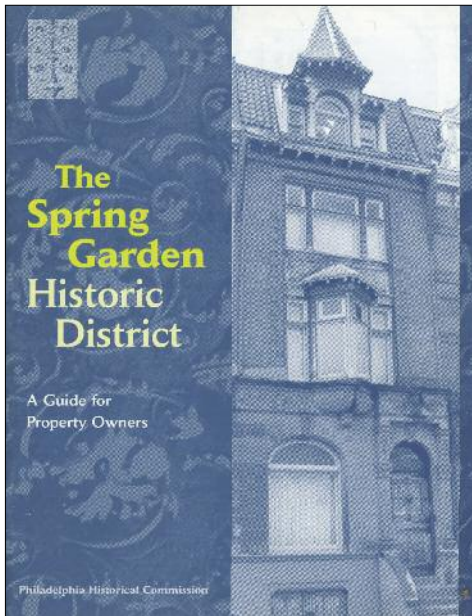

This is one of the manuals published by the City to guide owners of historic properties in their home improvements. The information is valuable for any old houses. This, and manuals for other districts, can be downloaded at [www.phila.gov/historical/base.html](http://www.phila.gov/historical/base.html)

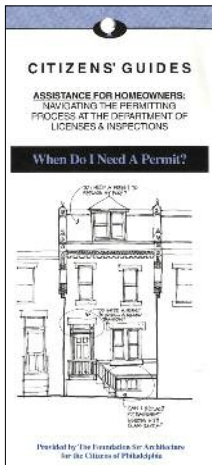

This pamphlet is among many useful guides to the city's permit process. It was produced by the Foundation for Architecture, and is available thanks to the Community Design Collaborative. You can download it at [www.philadelphiacfa.org](http://www.philadelphiacfa.org).

# Resources

The following is a partial list of some of the many useful sources of information and products for the rowhouse owner.

## Accessible Housing

### **HOUSING AND DISABILITY TECHNICAL ASSISTANCE PROGRAM**

Information about accessible rental and homeownership housing, fair housing laws, financial and technical resources and other issues.

#### **Philadelphia Office of Housing and Community Development**

215-576-1150, ext. 4  
[www.newsontap.org](http://www.newsontap.org)

## Building Materials

### **SUSTAINABLE DESIGN**

#### **Greenable**

126 Market Street  
Philadelphia  
215-922-6066  
[www.greenable.net](http://www.greenable.net)

#### **The Environmental Home Store**

550 Carpenter Lane, Philadelphia  
215-844-4733  
[www.environmentalhomestore.com](http://www.environmentalhomestore.com)

### **REPRODUCTION BUILDING MATERIALS**

#### **Period Homes**

The professional's Resource for Residential Architecture  
[www.period-homes.com](http://www.period-homes.com)

### **ARCHITECTURAL SALVAGE**

#### **Recycling the Past**

Barneгат, NJ  
[www.recyclingthepast.com](http://www.recyclingthepast.com)

#### **Provenance**

1610 Fairmount Ave.,  
Philadelphia, PA 19130  
1-215-769-1817  
[www.oldsoularchitecturalsalvage.com](http://www.oldsoularchitecturalsalvage.com)

## Carbon Monoxide

Carbon monoxide is an odorless, colorless toxic gas, often released by poorly maintained appliances, like furnaces or water heaters. The first line of defense is to regularly maintain these appliances. Carbon monoxide detectors (some in combination with smoke detectors) are widely available.

[www.epa.gov/iaq/co.html](http://www.epa.gov/iaq/co.html)

## Community Gardens

### **Neighborhood Gardens Association/Philadelphia Land Trust**

For Philadelphians lacking enough space for their own garden, more than 29 community gardens offer neighbors small plots for their own use. You can raise cut flowers or grow enough vegetables to feed a family. Some are so popular they have waiting lists. If your neighborhood doesn't have a community garden, think about starting one: Contact the Neighborhood Gardens Association/Philadelphia Land Trust go to [www.ngalandtrust.org/](http://www.ngalandtrust.org/) or call 215-988-8797

## Definitions

Can't tell the difference between a mullion and a muntin? Or a banister and a baluster? Useful information can be found in the

#### **Old-Home Dictionary by Steven J. Phillips or go to**

[www.doityourself.com](http://www.doityourself.com)  
[www.thisoldhouse.com](http://www.thisoldhouse.com)

## Energy Conservation

You can save money by installing energy-conservation features in your home. Following is a partial list of local agencies that provide free energy cost-cutting advice.

#### **Energy Coordinating Agency of Philadelphia**

215-988-0929  
[www.ecasavesenergy.org](http://www.ecasavesenergy.org)

#### **Philadelphia Housing Development Corporation**

Free weatherization and energy-efficient improvements to owner-occupied and rental units.  
215-448-2160  
[www.phdchousing.org](http://www.phdchousing.org)

### **PECO**

[www.exeloncorp.com/ourcompanies/peco/recovers](http://www.exeloncorp.com/ourcompanies/peco/recovers)

#### **Philadelphia Gas Works**

[www.pgworks.com](http://www.pgworks.com)

## Fire Safety

Change the batteries twice a year on your smoke detectors. Practice an emergency exit. Have a look at the useful Home Fire Safety Checklist:

#### **U.S. Fire Administration**

[www.usfa.dhs.gov/citizens/all\\_citizens/home\\_fire\\_prev/alarms/](http://www.usfa.dhs.gov/citizens/all_citizens/home_fire_prev/alarms/)

## Funding for Home Repairs

Before you sign for a home-improvement loan, check out these free home-repair programs as well as the city's low-interest rate loan program. Income guidelines and other eligibility requirements apply.

### **BASIC SYSTEMS REPAIR PROGRAM**

Free adaptations to house or apartment of physically disabled homeowners and renters.

#### **Philadelphia Housing Development Corporation**

215-448-2160  
[www.phdchousing.org](http://www.phdchousing.org)

### **EMERGENCY HEATER HOTLINE**

Free minor heater repairs.

#### **Energy Coordinating Agency of Philadelphia**

Homeowners: 215-568-7190  
Renters: 215-686-2590  
[www.ecasavesenergy.org](http://www.ecasavesenergy.org)

### **HISTORIC PROPERTIES REPAIR PROGRAM**

Grants for exterior repairs and restoration work to owner-occupied homes to maintain neighborhood's historic character.

#### **The Preservation Alliance for Greater Philadelphia**

215-546-1146, ext. 2  
[www.preservationalliance.com/programs/historic-repair-grant.php](http://www.preservationalliance.com/programs/historic-repair-grant.php)

**PHILADELPHIA HOME IMPROVEMENT  
LOANS (PHIL)**

Low-interest home improvement loans up to \$25,000 to qualified homeowners through participating banks.

**Philadelphia Redevelopment  
Authority**

877-487-4452  
[www.PhilaLoan.com](http://www.PhilaLoan.com)

**PROPERTY TAX ABATEMENT**

10-year tax exemption on increased value of renovated home.

**City of Philadelphia**

215-686-4334  
[www.brtweb.phila.gov](http://www.brtweb.phila.gov)

**SENIOR HOUSING ASSISTANCE  
REPAIR PROGRAM (SHARP)**

Free minor repairs to homes of elderly Philadelphians.

**Philadelphia Corporation for Aging**

215-765-9040  
[www.pcacares.org](http://www.pcacares.org)

**Homeownership**

These programs are designed to help you purchase a home for the first time in Philadelphia. Income guidelines and eligibility requirements apply.

**AMERICAN DREAM  
DOWNPAYMENT INITIATIVE**

Up to \$10,000 toward down payment and closing costs to qualified first-time buyers in specific new-construction developments or specific rehabilitated houses.

**SETTLEMENT GRANT ASSISTANCE**

Up to \$800 toward closing costs to qualified first-time buyers of Philadelphia homes. Must apply to an approved housing counseling agency before signing an agreement of sale.

**Philadelphia Office of Housing and  
Community Development**

[www.phila.gov/ohcd](http://www.phila.gov/ohcd)  
215-686-9723

**SHERIFF SALES**

Tax-delinquent properties are sold to the highest bidder at public auction.

**Philadelphia Sheriff's Office**

[www.phillysheriff.com](http://www.phillysheriff.com)  
215-686-3535



## Housing Counseling

Housing counseling agencies, located in neighborhoods citywide, provide free pre- and post-purchase counseling to first-time homebuyers. Services include counseling regarding predatory loans, mortgage foreclosures and reverse mortgages. Income guidelines and other eligibility requirements apply.

### **DON'T BORROW TROUBLE HOTLINE**

Predatory lenders try to high-pressure you into signing for a loan with excessive fees and penalties. Call the hotline for free advice BEFORE borrowing against your house for home improvements, mortgage refinancing or debt consolidation. Also call the hotline if you think you've been a victim.

#### **Office of Housing and Community Development**

[www.phila.gov/ohcd](http://www.phila.gov/ohcd)  
215-523-9520

## Lead Poisoning

Houses more than 25 years old often have paint, soil or dust containing lead which, if ingested by young children, can cause brain damage.

### **CHILDHOOD LEAD POISONING PREVENTION PROGRAM**

Arranges inspection, risk assessment and lead-hazard abatement of privately owned housing where children under 6 have been identified as lead-poisoned or at risk for lead poisoning.

#### **City of Philadelphia**

[www.phila.gov/health/units/lead](http://www.phila.gov/health/units/lead)  
215-685-2797

## Radon

Although professional testing is always the most reliable, home monitoring devices are available from many websites, such as:  
[www.healthgoods.com/Shopping/Home\\_Test\\_Kits/Radon\\_Testing.asp](http://www.healthgoods.com/Shopping/Home_Test_Kits/Radon_Testing.asp)  
[www.epa.gov/radon/pubs/citguide.html](http://www.epa.gov/radon/pubs/citguide.html)

## Safety

### **Operation Town Watch**

Town Watch groups proactively take charge of reducing crime in their neighborhoods. Operation Town Watch, helps residents work with police to reduce crime and drug-related activity.

[www.phila.gov/townwatch/contact.html](http://www.phila.gov/townwatch/contact.html)  
or call 215-686-1453.

## Street Trees

### **SELECTING TREES**

Street trees not only beautify a block, they add to a home's value. You can obtain a list of species best for Philadelphia's climate from the Fairmount Park Commission. The Commission is also responsible for the planting, maintenance and removal of all street trees.

#### **Fairmount Park Commission**

[www.fairmountpark.org/streettree.asp](http://www.fairmountpark.org/streettree.asp)  
215-685-4363

### **TREE CARE TRAINING**

Offers free courses such as Tree Tenders and TreeVitalize.

#### **The Pennsylvania Horticultural Society**

[www.pennsylvaniahorticulturalsociety.org/phlgreen/city\\_gardner.html](http://www.pennsylvaniahorticulturalsociety.org/phlgreen/city_gardner.html)  
215-988-8844

## Trash & Recycling

### **TRASH DAY—BEING NEIGHBORLY; HANDLING IT LEGALLY**

Trash and recycling should be set out after 7 PM the night before collection day and before 7 AM the next morning at your regularly scheduled pickup site. If a pickup falls on a holiday, put the trash out the day after. If you are unsure of your collection day, call the Streets Department at 215-686-5560. Place trash on your property.

Residents are required to keep their property and the sidewalk free of trash and litter. Sweep litter into proper containers, never into the street.

Clearing sidewalks of snow is also a resident's responsibility. No later than six hours after the end of a snowfall or freezing rain, you must clear a path at least 30 inches wide. Do not shovel the snow into the street.

#### **City of Philadelphia, Customer Affairs Unit**

[www.phila.gov/streets/sweep.html](http://www.phila.gov/streets/sweep.html)  
215-686-5560

### **RECYCLING**

The City of Philadelphia requires that all households recycle. Containers are provided for storage during the week. You can recycle more materials (plastics, cardboard, etc) at certain locations throughout the city.

#### **Recycling Alliance of Philadelphia**

[www.cleanair.org/recyclingalliance/](http://www.cleanair.org/recyclingalliance/)

## Windows

### **HARD TO FIND WINDOW PARTS**

1-800-842-0974  
[www.windowrepairsystems.com](http://www.windowrepairsystems.com)

### **STORM WINDOWS**

[www.eere.energy.gov/consumer/your\\_home/windows\\_doors\\_skylights/index.cfm/mytopic=13490](http://www.eere.energy.gov/consumer/your_home/windows_doors_skylights/index.cfm/mytopic=13490)

[www.img.diynetwork.com/DIY/2003/09/18/hes101\\_3fr\\_e.jpg](http://www.img.diynetwork.com/DIY/2003/09/18/hes101_3fr_e.jpg)



The diagram we used throughout the manual is based on a full sized model house that was built in 1893 for the World's Fair in Chicago. Philadelphia was known as the City of Homes.

*"The two-story dwellings of this city are, beyond all question, the best, as a system, not only owing to the single family ideas they represent, but because their cost is within the reach of all who desire to own their own homes. They have done more to elevate and to make a better home life than any other known influence. They typify a higher civilization, as well as a truer idea of American home life, and are better, purer, sweeter than any tenement house systems that ever existed. They are what make Philadelphia a city of homes, and command the attention of visitors from every quarter of the globe."*

FRANK H. TAYLOR, ED., *THE CITY OF PHILADELPHIA AS IT APPEARS IN THE YEAR 1894*, 2ND ED. (PHILA, 1894)

Between 1887 and 1892, nearly 45,000 new houses were built, most of which were rowhouses, worth an average of \$3,000. Many of them were variations on this two story model. More citizens owned their own single family homes in Philadelphia during this time than any other major American city. Because of the growing industrial production in the City, good affordable housing for working people was a necessity. Between 2001 and 2006, 1,350 new homes were built, at an average cost of \$160,000 each.





